

## Installation, Operation and Maintenance Manual

Please read and save these instructions for future reference. Read carefully before attempting to assemble, install, operate or maintain the product described. Protect yourself and others by observing all safety information. Failure to comply with these instructions will result in voiding of the product warranty and may result in personal injury and/or property damage.

### Table of Contents

Reference part number listed in chart to locate specific motor information page number.

HP	Voltage	* RPM Range	Encl.	FLA	Control Method	Motor Part No.	Pg.
1/10	115	300-1725	TENV	1.5	Pot/0-10V	318003	4
1/10	115/208-230/277	300-1750	ODP	1.38/0.84/0.73	Pot/0-10v	319356	4
1/6	115/208-230/277	300-1750	ODP	2.2/1.3/1.1	Pot/0-10v	319357	4
1/6	115	300-1725	TENV	2.6	Pot/0-10V	318004	4
				3.1	0-10V Only	311352	3
				3.1	Pot Only	311353	
				3.4	Pot/0-10V	311731	3
						312359	
313712							
1/6	208-240	300-1725	TENV	1.6	Pot/0-10V	313233 313713	3
1/6	277	300-1725	TENV	1.15	Pot/0-10V	316495	3
1/4	115/208-230/277	300-1725	ODP	2.85/1.7/1.5	Pot/0-10V	318013	4
1/4	115	300-1725	ODP	3.9	0-10V Only	310107	3
				3.9	Pot Only	310108	
				3.7	Pot/0-10V	311377	3
						313714	
1/4	208-240	300-1725	ODP	2.3	Pot/0-10V	313234 313715	3
1/4	277	300-1725	OPD	1.8	Pot/0-10V	316496	3
1/3	115/208-230/277	300-1725	ODP	4.4/2.6-2.4/2.2	Pot/0-10V	320587	4
1/2	115	300-1725	ODP	6.2	0-10V Only	309025	3
				6.2	Pot Only	309028	
				6.7	Pot/0-10V	311812	3
1/2	208-240	300-1725	ODP	4.2	Pot/0-10V	313235	3
1/2	277	300-1725	ODP	3.3	Pot/0-10V	316497	3
1/2	115	300-2500	ODP	6.5	0-10V Only	310307	3
				6.5	Pot Only	310476	
				6.5	Pot/0-10V	312360	3
1/2	208-240	350-2500	ODP	4.9	Pot/0-10V	317706	3
1/2	277	3500-2500	ODP	3.27	Pot/0-10V	317707	3
1/2	115/208-230/277	300-1725	ODP	6.4/3.8-3.6/3.2	Pot/0-10V	320588	4

HP	Voltage	* RPM Range	Encl.	FLA	Control Method	Motor Part No.	Pg.
3/4	115	300-1725	ODP	10.1	0-10V Only	309026	3
				10.1	Pot Only	309029	
				10.6	Pot/0-10V	311388 312619	3
3/4	208-240	300-1725	ODP	6.6	Pot/0-10V	314534	3
3/4	277	300-1725	OPD	5.4	Pot/0-10V	316498	3
3/4	115	300-2200	ODP	11.3	0-10V Only	310306	3
				11.3	Pot Only	310475	
				11.3	Pot/0-10V	312361	3
3/4	208-240	350-2200	OPD	5.6	Pot/0-10V	317708	3
3/4	277	350-2200	OPD	4.7	Pot/0-10V	317709	3
3/4	115/208-230/277	300-1725	OPD	8.8/5.4-5.0/4.8	Pot/0-10V	320589	4
1	115	300-1725	ODP	12.4	Pot/0-10V	310359	3
						312362	
1	115/208-240	300-1725	TEFC	12.0/6.0	Pot/0-10V	311156	5
1	208-240	300-1725	ODP	8.6	Pot/0-10V	314945	3
1	277	300-1725	ODP	7.3	Pot/0-10V	316499	3
1	115/208-230/277	300-1725	ODP	11.5/7.0-6.5/5.8	Pot/0-10V	320590	4
						310420	
2	208-240	300 - 1725	TEFC	12.0	Pot/0-10V	310420	5

\*Actual maximum RPM may vary. See RPM column in chart on page 11 for specific motor and fan combinations.

Controls . . . . . 7-11  
Maximum RPM Table . . . . . 12

# Vari-Green® Motor

The Vari-Green Motor is an electronically commutated (EC) motor that uses AC input power and internally converts it to a DC power supply which provides an 80% turndown capability and increased energy savings.

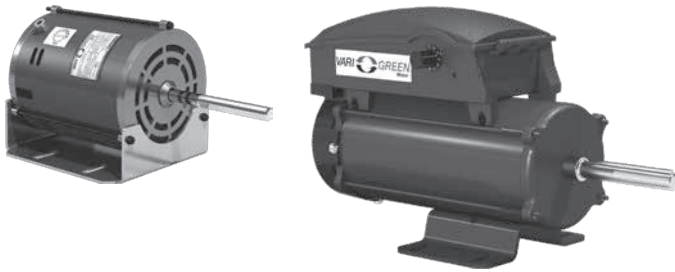

## Features, Operation and Wiring, and Troubleshooting

### Features

**Soft start** – All motors feature soft-start technology which eliminates inrush current at start-up. The motors will reliably start at any speed setting.

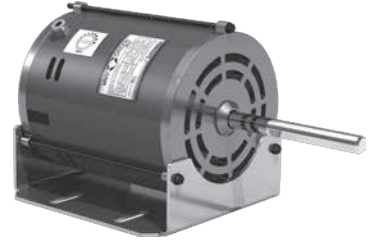

**Overload protection** – If the motor becomes overloaded, it will automatically reduce its speed until it is no longer overloaded. This means that the motor will never operate in the “service factor” which is possible with many AC motors.

**Locked rotor protection** – If the motor ever encounters a locked-rotor scenario, the motor will automatically shut itself down. It will try to restart up to 3 times, and if after the 3rd time the motor will still not rotate, the motor will not attempt to start again until power is cycled.

**Thermal protection** – The motors have a one-shot fuse thermal protector. This is meant to protect the motor from a severe temperature rise. Additionally, the motors have on-board temperature sensors which will reduce the speed of the motor should it become too hot. The fuse is used as a last resort to prevent a fire.

**RPM measurement** – The motors have a small shaft extension on the end of the motor to measure motor RPM with either a contact or optical tachometer.

### NOTE

When using a clamp meter to measure input amp draw, the meter must be capable of reading a non-linear current. Erroneous readings will occur otherwise.

### WARNING

To reduce the risk of fire or electric shock, do not use this motor with any solid-state speed control device.

Fig. 1 0-10 VDC External connection with factory mounted transformer (See page 4 for details)

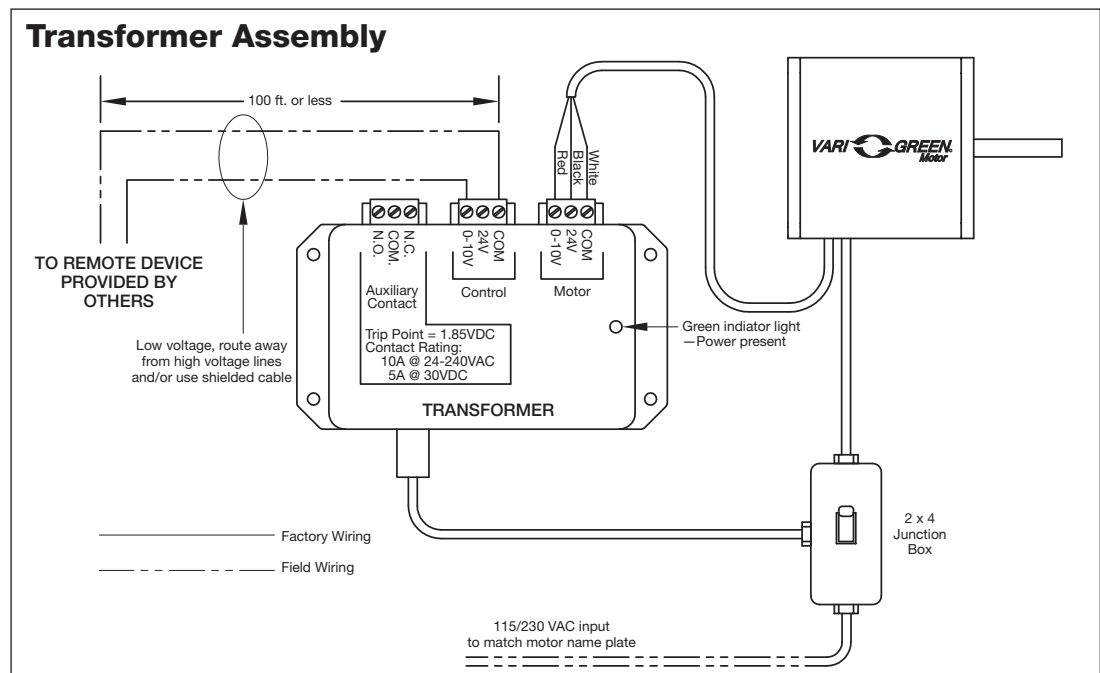

## Operation and Wiring

### - Potentiometer Dial Only

Part Numbers Covered in this Section				
309028	309029	310108	310475	310476
311353				

These motors feature a potentiometer dial on the motor for speed adjustment. A small screwdriver can be used to make the speed adjustment. To increase the speed, rotate the dial clockwise. To decrease the speed, rotate the dial counterclockwise.

The motor is pre-wired at the factory and cannot be changed inside the motor. Connect single-phase power at the voltage listed on the nameplate.

These motors cannot be converted to receive a remote control signal – a different motor is needed. Please consult the factory.

## Operation and Wiring

### - 0-10V Input Only

Part Numbers Covered in this Section				
309025	309026	310107	310306	310307
311352				

These motors will accept a 0-10 VDC control signal for speed control. From 0-1.9V, the motor will be off, and will operate in the 2-10V range. 24 VAC/DC power is also required for operation. The motor will consume 0.7VA at 24 VAC or 25mA at 24 VDC. A factory mounted transformer is available to supply this voltage. (See Fig. 1)

The motor is pre-wired at the factory and cannot be changed inside the motor. Connect single-phase power at the voltage listed on the nameplate, along with the 0-10 VDC and 24V signal for speed control.

NOTE: The motor will not operate without the proper control voltages.

## Operation and Wiring

### - Potentiometer Dial and 0-10V Input

Part Numbers Covered in this Section				
310359	311731	311377	311388	311812
312359	312360	312361	312362	312619
313233	313234	313235	313712	313713
313714	313715	314534	314945	316495
316496	316497	316498	316499	317706
317707	317708	317709		

These motors have both a potentiometer dial on the motor for speed adjustment AND have the ability to accept a 0-10 VDC signal for remote speed control.

There is a 4 second delay between the application of power and the motor starting.

The motor is pre-wired at the factory and cannot be changed inside the motor. Connect single-phase power at the voltage listed on the nameplate. If remote control is desired, connect the 0-10 VDC and 24V signal for remote speed control.

**Dial on Motor** – A small screwdriver can be used to make the speed adjustment. To increase the speed, rotate the dial clockwise. To decrease the speed, rotate the dial counterclockwise. There is no need to connect the control wires.

**0-10 VDC signal** – The dial on the motor must be rotated fully clockwise to achieve the full speed range. If this is not done, the dial will act as a maximum speed limiter.

From 0-1.9V, the motor will be off, and will operate in the 2-10V range. 24 VAC/DC power is also required for operation. The motor will consume 0.7VA at 24 VAC or 25mA at 24 VDC. A factory mounted transformer is available to supply this voltage. (See Fig. 1, page 2)

A low voltage wiring harness is needed to supply the 0-10V signal to the motor. This harness is available from the factory if conversion is necessary.

Low Voltage Harness Part Numbers			
Type	Use with Motor	18 in. long	36 in. long
3-pin	311731, 310359	384431	384432
9-pin	312359, 311377, 311812, 311388, 312360, 312361, 312362, 312619, 313233, 313234, 313235, 313712, 313713, 313714, 313715, 314534, 314945, 316495, 316496, 316497, 316498, 316499, 317706, 317707, 317708, 317709	384804	384805

### NOTE

The 9-pin connector on the motor contains 6 wires. The red, black and white wires are used for the external control signal and the other three are used for factory initialization and programming.

### 0-10V Analog input connection

Red	+ 0-10 VDC
White	Common*
Black	+24 VAC/DC
*Common is shared between both 24V power and 0-10V signal.	
The impedance of 0-10V circuit is 12KΩ	

## Troubleshooting

### Motor does not operate

1. Check all wiring connections to ensure they are correct and secure.
2. Verify that all voltages are present at the motor, including 24V and 0-10 VDC, if applicable.
3. Make sure that the fan wheel will rotate freely and there are no foreign objects in the wheel. If fan wheel does not rotate freely, disconnect power from the motor and adjust the wheel or housing until the wheel can freely rotate. Apply power and the motor should restart.
4. If motor has both the dial on the motor and 0-10 VDC control option, control wiring issues can be tested by disconnecting the control wires from the motor. The motor should then operate using the dial on the motor for speed control.

### Motor will not reach maximum speed

1. Make sure dial is rotated full clockwise, if applicable.
2. Make sure motor is receiving 10 VDC, if applicable.
3. There are some motor/fan combinations where the motor may not reach nameplate RPM. See Max RPM table on page 11 for the maximum motor speed for your application.

### Factory Mounted Transformer (Fig. 1, page 2)

A factory mounted transformer is available to supply 24 VDC power to the motor when the 0-10V signal is by others. This transformer has the capability to power a remote device if desired. The power available to a remote device is 400mA at 24 VDC. If the remote device is powered by a different source, connect the analog output to the 0-10V and COM terminals of the transformer. This will pass the signal through to the motor.

#### WARNING

Do not connect an external 24V supply to the transformer's control terminal labeled 24V. If the external device providing the 0-10V signal is powered elsewhere, this terminal can remain unused.

## Operation and Wiring

### - Potentiometer and 0-10V Input

#### Part Numbers Covered in this Section

318003	318004	318013	319356	319357
320587	320588	320589	320590	

These motors have the ability to accept a plug in potentiometer for speed adjustment AND the ability to accept a 0-10V signal for remote control.

There is a 4 second delay between the application of power and the motor starting.

**Motor part numbers 318003, 318004** – The motor is prewired at the factory and cannot be changed inside the motor. Connect single-phase power at the voltage listed on the nameplate.

**Motor part numbers 318013, 319356, 319357, 320587, 320588, 320589 and 320590** – The motor is prewired at the factory and can operate on 115v up to 277v. Operating voltage is changed via voltage jumper wire.

**Voltage jumper** – For 115v the red jumper wire on the side of the motor must be connected (closed). For 208v-277v operation the red jumper must be disconnected (open).

**Dial on Motor** – A potentiometer (p/n 385806) can be plugged into the 9-pin connector of the motor. To increase speed, rotate the dial clockwise. To decrease speed, rotate the dial counterclockwise.

**0-10 VDC Signal** – From 0-1.9V, the motor will be off, and will operate in the 2-10V range. A low voltage wiring harness is needed to supply the 0-10V signal to the motor. The harness is available from the factory if conversion is necessary.

#### Low Voltage Harness Part Numbers

Type	Use with Motor	18 in. long	36 in. long
9-pin	318003, 318004, 318013, 319356, 319357, 320587, 320588, 320589, 320590	385821	385822

#### NOTE

The 9-pin connector on the motor contains 6 wires. The yellow, orange, red and white wires are used for external control. The other two wires are used for factory initialization and programming.

#### 0-10V Analog Input Connection

Red	+ 0-10 VDC
White	Common

## Troubleshooting

### Motor does not operate

1. Verify the motor is wired correctly and all connections are secure.
2. If using dial on motor, verify the potentiometer is fully seated in the 9-pin connector.
3. If using 0-10 VDC, verify that all voltages are present at the motor.

### Motor does not reach maximum speed

1. Make sure dial is rotated full clockwise, if applicable.
2. Make sure motor is receiving 10 VDC, if applicable.
3. There are some motor/fan combinations where the motor may not reach nameplate RPM. See Max RPM table on page 11 for the maximum motor speed for your application.

## Part Numbers Covered in this Section

310420	311156
--------	--------

## Features

### Speed control -

These motors can be controlled by either a dial on the motor or a 0-10 VDC signal for remote control.



**Soft start** – All motors feature soft-start technology which eliminates inrush current at start-up. The motors will reliably start at any speed setting. There will be up to a 30 second delay between the application of power and the motor starting. The motor will "rock" back and forth upon startup as part of its normal operation.

**Overload protection** – If the motor becomes overloaded, it will automatically shut itself down. The maximum programmed motor speeds have been selected to prevent this from happening in normal operation.

**Locked rotor protection** – If the motor encounters a locked-rotor scenario, it will automatically shut itself down. It will try to restart up to 3 times, and if after the 3rd time the motor will still not rotate, the motor will not attempt to start again until power is cycled.

**Thermal protection** – The motors have an automatic reset thermal protector. This is meant to protect the motor from a severe temperature rise.

**RPM measurement** – The motor RPM can be measured by removing the cooling fan cover and using a contact or optical tachometer. Be sure to replace the cooling fan cover when finished.

**Reversible rotation** – The motor direction has been pre-set at the factory for the rotation of the fan but can be reversed if necessary.

## Operation and Wiring

These motors can be controlled by either a dial on the motor or a 0-10 VDC signal for remote control. The motor will be supplied from the factory with the correct accessory depending on what was ordered.

**Dial on Motor** - Turn the dial with your fingers to adjust. To increase the speed, rotate the dial clockwise. To decrease the speed, rotate the dial counterclockwise. Turning the dial full Counter Clock Wise will turn the motor off.

**0-10 VDC Signal** - From 0-1.9V, the motor will be off, and will operate in the 2-10V range. This motor does not require 24V power for operation.

0-10V Analog Input Connection	
Red	+ 0-10 VDC
White	Ground

### Wiring

1. All high and low voltage wiring connections are made inside the motor control box at the factory. Normally, there is no reason to enter the control box of the motor. If there is a need to enter the control box, disconnect power and wait at least five minutes to allow the capacitors to discharge.
2. The motors are factory wired for the ordered voltage. If the factory wired voltage does not match the desired voltage, the voltage can be changed, with exception of the 2HP motor (310420), which is 208-240V only.

**115V:** Connect 115 VAC to L1, connect Neutral to N. The L2 terminal remains empty. Connect ground to grounding stud.

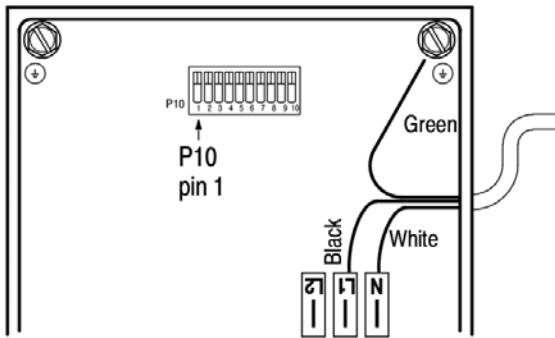

115V Connection inside control box

**208-240V** - Connect line voltage to L1 and L2. The N terminal remains empty. Connect the ground to the grounding stud.

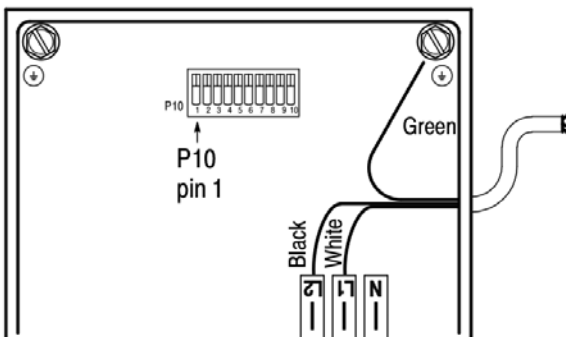

208-240V Connection inside control box

**Dial on Motor** - the dial is factory-wired into the low voltage terminal block inside the control box. The wires are connected as shown.

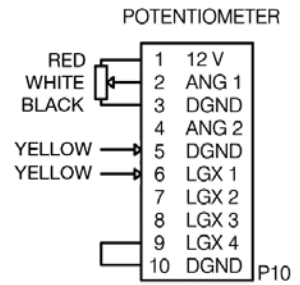

Dial on motor connection inside control box

**0-10 VDC Signal** - a two-wire pigtail is factory-wired into the low voltage terminal block. The wires are connected as shown.

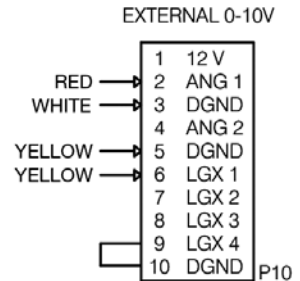

0-10 VDC signal connection inside control box

If the motor needs to be tested before the 0-10 VDC signal is available, a jumper can be placed between terminals 1 and 2. This will force the motor to run at full speed.

### Motor Rotation

To reverse the rotation of the motor, swap any two of the red, black and blue wires connecting the control board to the motor at terminals T1, T2 and T3. Note that motor warranty is void if motor is rotating in the wrong direction. See fan instruction manual for correct rotation direction.

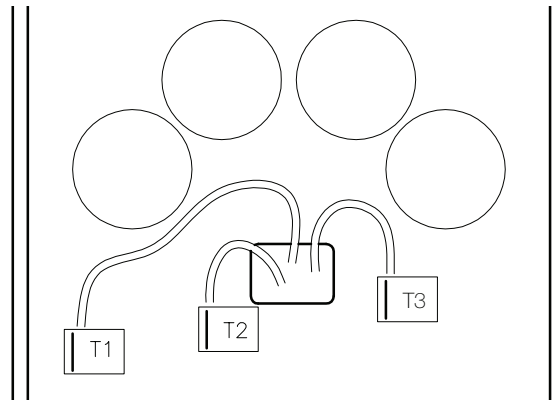

Rotation selection wires inside control box

## Troubleshooting

These motors have a diagnostic red LED on the circuit board inside the control box, or on the exterior of the control box, that will be solid (not flashing) when power is applied to the motor and the motor is operating normally. The LED may be solid even if the motor is not spinning, such as when power is applied but the motor may be commanded to be off with a 0-1.9V VDC signal.

1. If external LED is not present, to view the status of the LED the control box cover must be removed while power is applied to the motor. If the control box cover is removed while power is applied, extreme care must be taken not to touch any of the components inside the box.
2. If a fault occurs, the LED will blink a specific number of times to identify the fault that has occurred. The fault indications are as follows:

Number of Blinks	Indicated Fault
2	Hardware Fault
3	Overvoltage
4	Undervoltage
5	Communication Error
6	Sync Loss
7	Spin Fault
8	Motor Overload
9	Motor Over Temperature

3. When the LED is blinking, it will consecutively blink from 2 to 9 times, followed by a pause, and repeat the blink sequence. It is best to count the number of flashes 2 or 3 times to ensure accuracy.
4. Under most fault conditions the motor will automatically restart. If a motor overload fault occurs more than 10 times in one hour, the motor will shut down and require a power cycle to reset.
5. If the fault persists, consult the factory.

## Motor does not operate

1. Verify the motor is wired for the correct voltage.
2. Verify that the dial on the motor is properly connected to the control board - or - verify that the 0-10 VDC wires are properly connected to the control board.
3. Verify that the Status LED is solid red.
4. Verify that a jumper is in place between terminals 9 and 10. The motor will not run without this jumper in place.
5. Verify that the two yellow wires coming from the motor are in place on terminals 5 and 6.

## Controls: Operation, Wiring and Troubleshooting Remote Dial/Touch Remote and 2-Speed Control

### Remote Dial

Installation Overview: The remote dial is provided with the fan, shipped loose for remote installation. It also includes a factory mounted 24 VDC transformer.

1. Disconnect power to the fan.
2. Identify where the remote dial will be mounted.
3. Mount a standard single-gang 2x4 junction box.
4. Run a 3-wire control cable from the remote dial to the fan motor compartment. The maximum distance from the fan to the remote dial is 100 feet. If a greater distance is required, signal loss may occur and cause the fan to operate erratically.
5. Connect control cable to transformer mounted inside fan motor compartment. Connect control cable to remote dial.
6. Secure remote dial to 2x4 junction box.

### Remote Dial with Min/Max Setting

Remote dials (P/N 385803) are capable of setting minimum and maximum voltage limits. Setting voltage limits will require a multi-meter. To set a voltage span:

1. Install and wire remote dial as previously instructed.
2. Install multi-meter probes into the red (0-10v) and black (ground) connectors.
3. To set maximum voltage limit, apply power to the motor, transformer and remote dial. With remote dial set to zero (0), hold the Upper Limit button down and turn the dial until the desired voltage is displayed on your multi-meter. Release button to save max voltage setting.
4. To set lower voltage, turn remote dial back to zero (0). Hold down Lower Limit button while turning dial to desired voltage on your multi-meter. Release button to set minimum voltage limit.
5. To reset to default (0-10v) limits, hold both Upper and Lower limit buttons down simultaneously until the LED indicator lights up. Then release buttons and default levels will be restored.

**NOTE:** Upper voltage limit must be set prior to setting lower voltage limit. Upper and lower limits can only be within 0.5v of each other.

## Touch Remote

Follow installation instructions for remote dial above. After power is applied to the system, operate as follows:

1. Touch power button to turn fan on.
2. Touch UP/DOWN arrow to increase/decrease speed.
3. Subsequent touches of the power button will start the countdown timer of 90, 60, 30 or 10 minutes.
4. LED's will turn off after a period of inactivity.
5. To lock/unlock buttons, hold the UP and DOWN arrows for 3 seconds. When locked, the power button will light up red.

Other Vari-Green® controls, such as the Constant Pressure and Air Quality families of controls, have their own manual that ship with the controller. They can also be found on Greenheck.com. See table on page 10 for document numbers.

### CAUTION

Even though the motor may not be operating, high voltage power may still be present at the motor. Make sure to disconnect power to the fan before servicing.

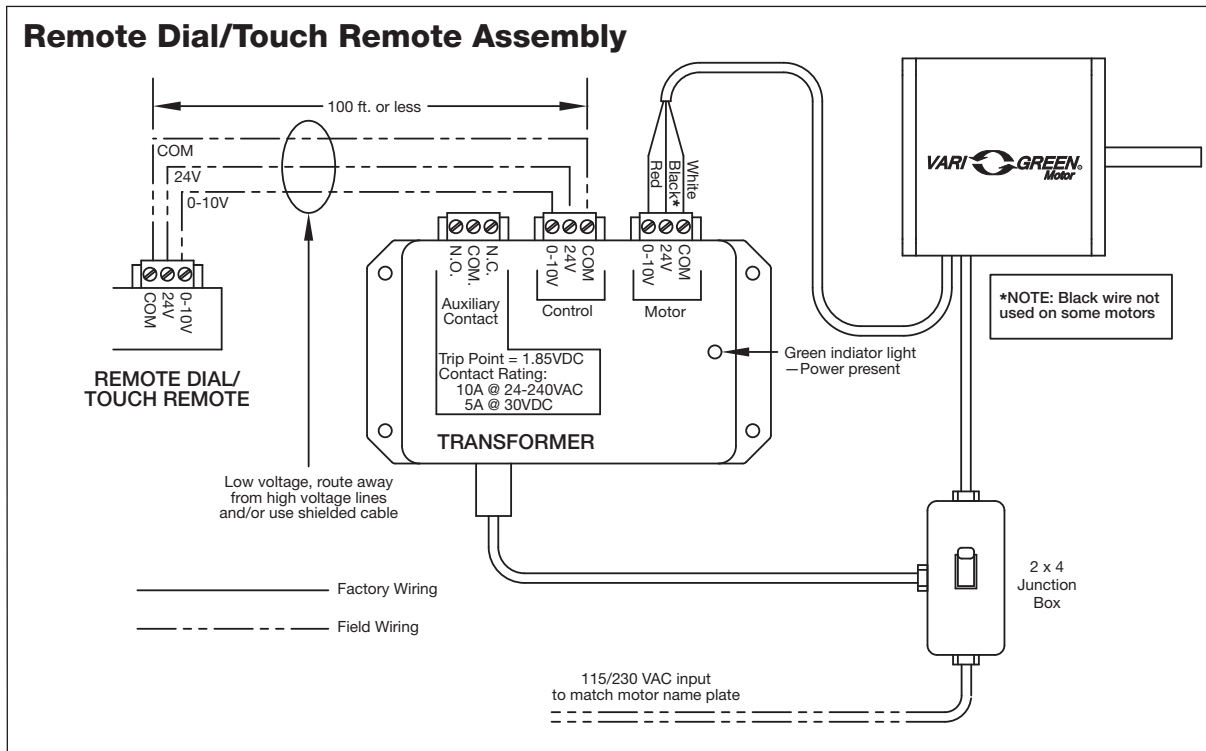

## Remote Dial with Min/Max Setting

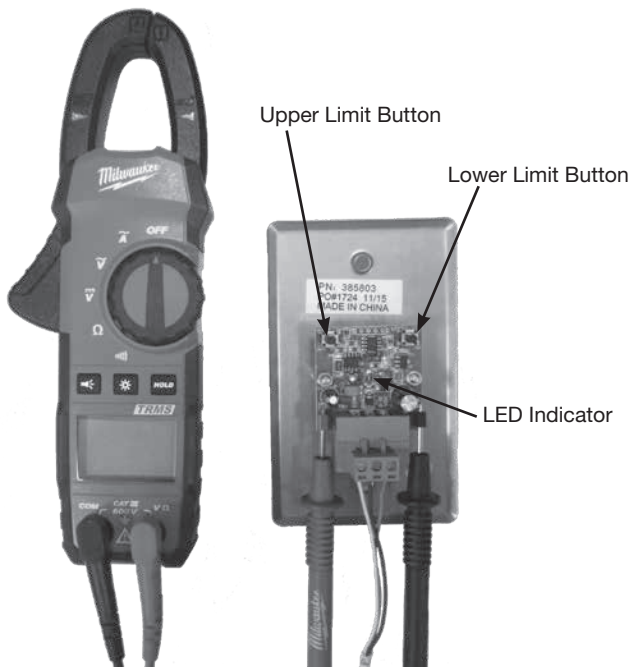

## Troubleshooting - Remote Dial/Touch Remote

### Remote Dial does not adjust motor RPM

1. Check voltage to ensure the motor and transformer are receiving the correct line voltage.
2. Check voltage at the remote dial. 24 VDC should be present across the 24V and COM terminals. 0-10 VDC should be present across the 0-10V and COM terminals.
3. Verify all of the connections at the transformer and make certain that they are secure.
4. Touch remote: Verify that the touch remote is unlocked.
5. To reset to default (0-10v) limits, hold both Upper and Lower limit buttons down simultaneously until the LED indicator lights up. Then release buttons and default levels will be restored.

Terminals	Desired Voltage
24V-COM	24 VDC Nominal
0-10V-COM	0-10 VDC (varies with dial position)



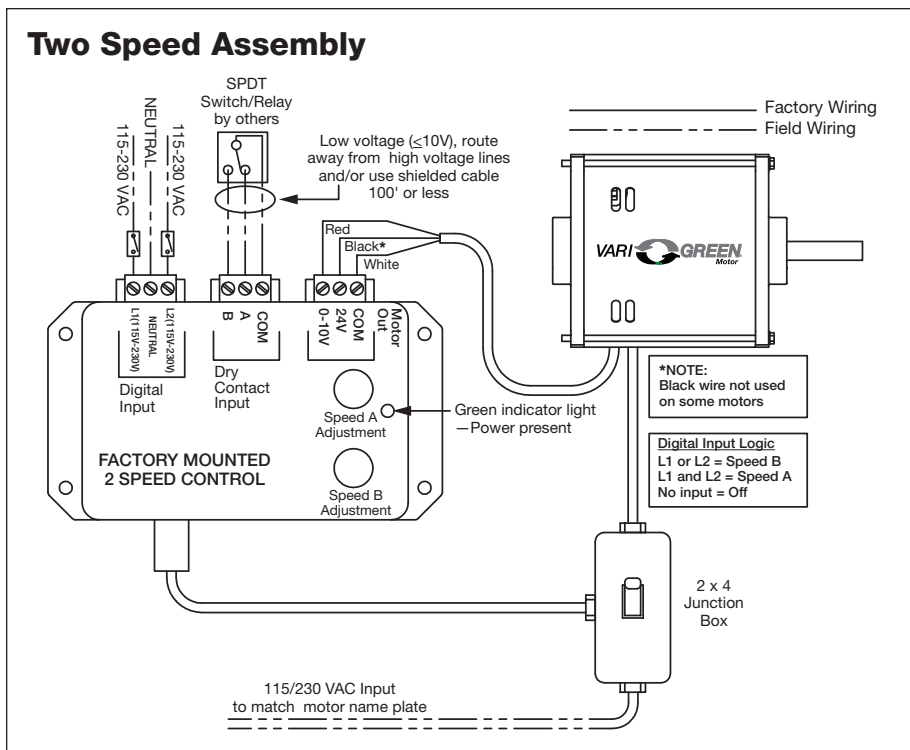

## Two Speed Control

Installation Overview: The two speed control is factory mounted to the fan and may be set to provide any two speeds the application requires. It also includes a 24 VDC transformer. A green LED will be illuminated when the 2-speed control is powered.

1. There are two methods of toggling between speed A and speed B:

a. **Dry contact input** - this utilizes an external switching device such as a relay or SPDT switch to toggle between the two speeds.

- Connect terminal "A" to "COM" for speed A.
- Connect terminal "B" to "COM" for speed B.

If no contact is made between either terminal the motor will be off.

b. **AC digital input** - this input allows an AC voltage signal to be fed directly into the 2-speed control to change speeds.

- Send 115-230V AC to L1 **OR** L2 for speed B.
- Send 115-230V AC to L1 **AND** L2 for speed A.

If no voltage is applied to either terminal, the motor will be off.

c. **DO NOT CONNECT BOTH DRY CONTACT AND DIGITAL INPUTS SIMULTANEOUSLY.**

2. To test fan operation before the external control devices are installed, a jumper wire can be connected between the COM and A or B terminal on the dry contact input for fan operation.

## Troubleshooting - Two Speed Control

1. Check all wiring connections to ensure they are correct and secure.
2. Verify AC line voltage is present at the motor and 2-speed control.
3. Verify 24 VDC is present at the 24V and COM terminals of the "Motor" terminal block.
4. Measure DC voltage between the 0-10V and COM terminals of the "Motor" terminal block. This voltage should match the dial position of the active dial.
  - a. If using dry contact input - ensure contact closure is connecting the proper terminals.
  - b. If using AC digital input - disconnect connector from 2-speed control and measure voltage between L1 and Neutral or L2 and Neutral.

## Motorized Backdraft Damper Control

The available factory mounted transformer (PN 385253) has the ability to signal a motorized back draft damper to open/close as the motor starts/stops.

A N.O./N.C. set of contacts is provided which will change state when above or below a control voltage of 1.85 VDC. See wiring diagram for example.

### Contact Rating:

- 10A @ 24-240 VAC
- 5A @ 30 VDC

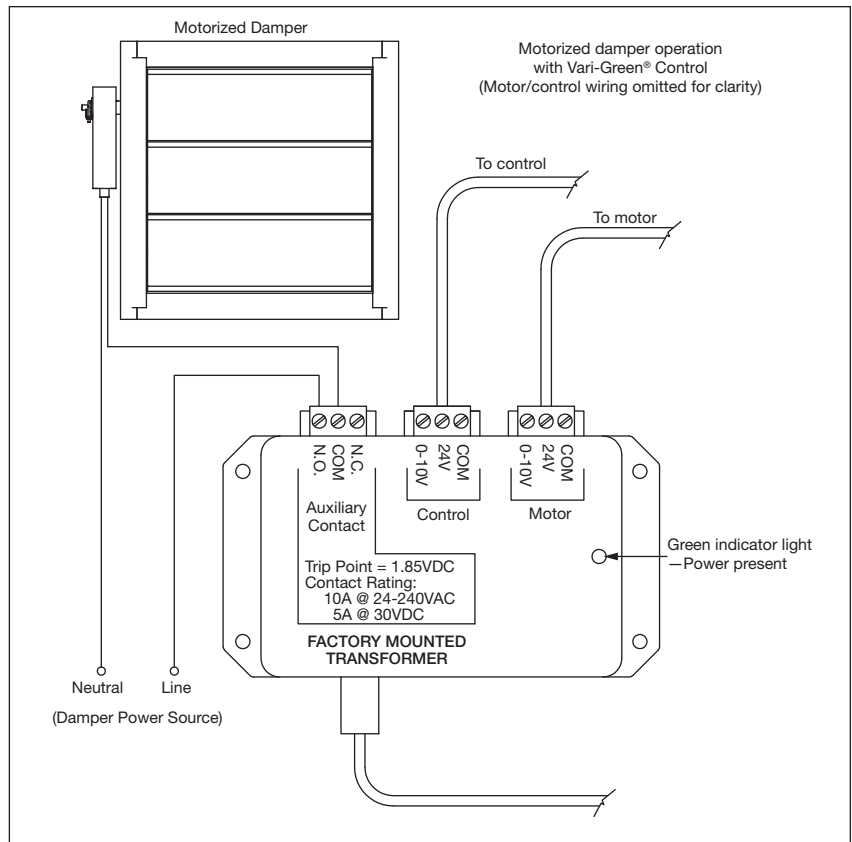

## Fans Where Dial on Motor is Not Accessible

A control is available to mount on the outside of a fan where the dial on motor may be difficult to access (model SQ). This control is powered by the line voltage entering the fan and will send 24 VDC and 0-10 VDC to the motor. Control Part Number is 385611

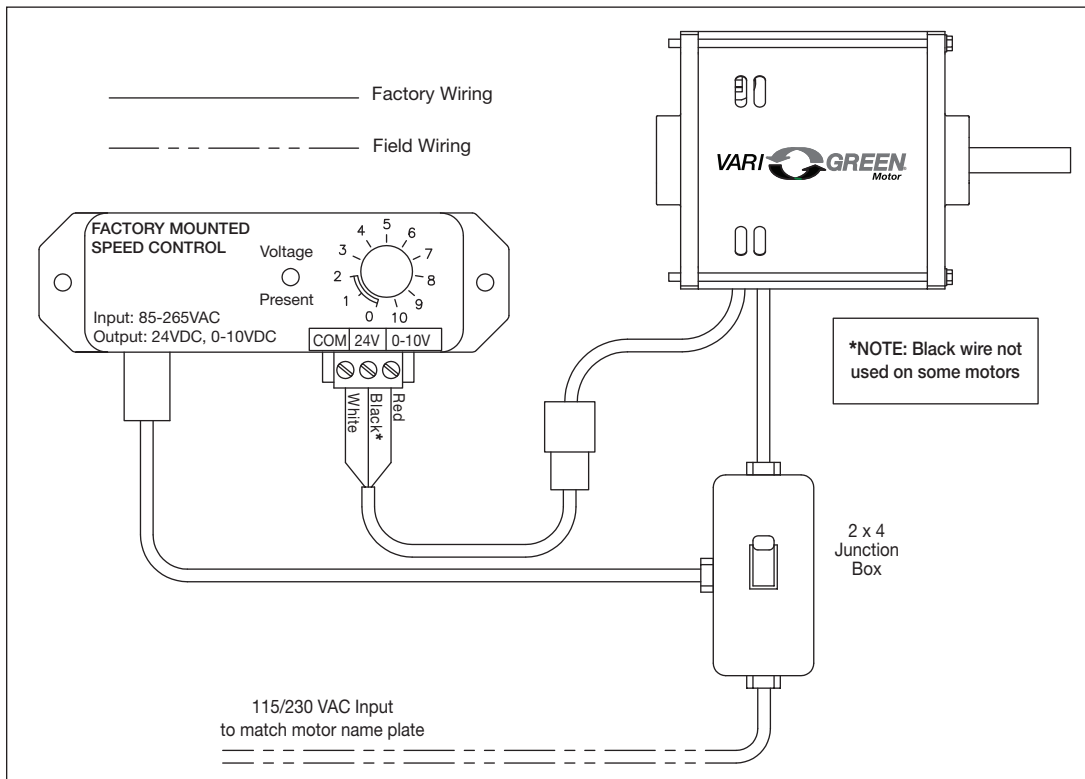

## Multiple Motors on One Control

See the table below for the recommended number of motors to be driven from one controller. Note that the controllers do not have the ability to distinguish between more than one motor, therefore all motors will receive the same control voltage. Control voltage must be wired in parallel to all motors.

Controls	Max. Motor Quantity
Remote Dial	4
2-speed	6
Constant Pressure/Airflow	4
Temperature/Humidity	2
VOC	2

## Maintenance

Vari-Green<sup>®</sup> motors use brushless technology with sealed bearings. No routine maintenance is required other than keeping any debris from accumulating on the motor and controls.

## Other Vari-Green<sup>®</sup> Control Instruction Manuals

Description	Document Number
Indoor Air Quality - VOC	475407
Indoor Air Quality - Temperature/Humidity	475573
Constant Pressure Control	474766
Generation 2 Constant Pressure/Airflow Control	479653

## Maximum RPM Table

This table will show the available motor and fan combinations with the correlating maximum motor RPM for each combination.

CUE/CW	Max RPM	Motor HP
60-90	1725	1/10
95	1725	1/6
99	1725	1/4
101	1725	1/4
101HP	1725	1/4
	2500	1/2
121	1400	1/4
	1725	1/2
131	1200	1/4
	1450	1/2
	1725	3/4
141	1000	1/4
	1300	1/2
	1550	3/4
	1725	1
141HP	1450	1/4
	1725	1/2
	2200	3/4
161	1000	1/2
	1200	3/4
	1300	1
	1725	2
161HP	1300	1/2
	1650	3/4
	1725	1
180	875	3/4
	1000	1
	1325	2

SQ	Max RPM	Motor HP
60-90	1725	1/10
95	1725	1/6
97	1725	1/4
	2500	1/2
98	1725	1/4
	2200	3/4
99	1725	1/4
	2200	3/4
100	1725	1/4
120	1725	1/2
130	1725	3/4
130HP	1250	1/4
	1450	1/2
	1950	3/4
140	1500	3/4
	1725	1
140HP	1100	1/2
	1450	3/4
	1725	1
160	1140	3/4
	1300	1
	1725	2
	850	1/2
160HP	1000	3/4
	1600	1
	1725	2

SFD	Max RPM	Motor HP
6	1725	1/4
7.5	1725	1/2

SWD	Max RPM	Motor HP
7	1725	1/4
	2500	1/2
8	1725	1/4
	2500	1/2
10	1725	1/4
	2200	3/4
13	1200	1/4
	1550	1/2
	1725	3/4
15	1150	1/2
	1400	3/4
	1725	1
16	900	3/4
	1300	1
	1725	2
18	850	3/4
	950	1
	1300	2

SE1/SS1	Max RPM	Motor HP
8-440*	1725	1/10
10-440*	1725	1/6
12-426	1725	1/4
12-432	1725	1/4
12-436	1725	1/4
14-432	1725	1/4
14-436	1725	1/2
14-440	1725	1/2
16-421	1725	1/2
16-426	1725	1/2
16-428	1725	3/4
16-436	1725	3/4
18-424	1725	3/4
18-429	1725	3/4
20-420	1725	1

**\*SE1 Model Only**

G	Max RPM	Motor HP
60-90	1725	1/10
95	1725	1/6
97-99	1725	1/4
103	1725	1/4
103HP	1725	1/4
	2500	1/2
123	1200	1/4
	1725	1/2
133	1150	1/4
	1550	1/2
	1725	3/4
143	900	1/4
	1200	1/2
	1300	3/4
	1725	1
143HP	1500	1/4
	1725	1/2
	2200	3/4
163	750	3/4
	1200	1
	1725	2
183	900	3/4
	1000	1
	1325	2

LD/LDP	Max RPM	Motor HP
80-90	1725	1/10
95	1725	1/6
100	1725	1/4
120	1725	1/2

SP/CSP	Max RPM	Motor HP
510	1200	1/6
710	1510	1/4

## Our Commitment

*As a result of our commitment to continuous improvement, Greenheck reserves the right to change specifications without notice.*

Specific Greenheck product warranties are located on [greenheck.com](http://greenheck.com) within the product area tabs and in the Library under Warranties.

AMCA Publication 410-96, Safety Practices for Users and Installers of Industrial and Commercial Fans, provides additional safety information. This publication can be obtained from AMCA International, Inc. at [www.amca.org](http://www.amca.org).

