



SKU
SP-A90-QD

Job Name:
Mark:
Submitted By:
Date: 04/24/2026

Bathroom Exhaust Fan, Product # SP-A90-QD, 80-114 CFM



- Motion and humidity sensing grille options available
- Acoustic insulation absorbs sound ensuring quiet operation
- ENERGY STAR rated
- External electrical access reduces installation time
- Industry leading low sound levels
- Speed controllable
- Spring loaded aluminum backdraft damper eliminates rattling
- Designer grille included

Certifications

AMCA Air & Sound
UL/cUL 507

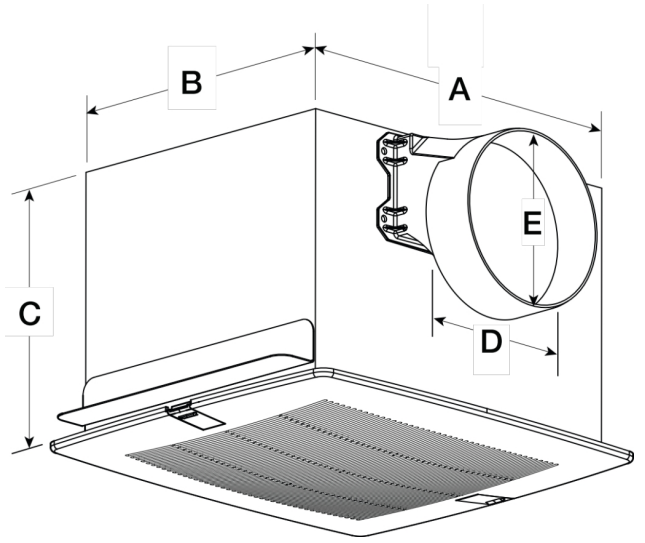

A	B	C	D	E
13.25 in	10.625 in	9 in	6 in	6 in

Performance Characteristics

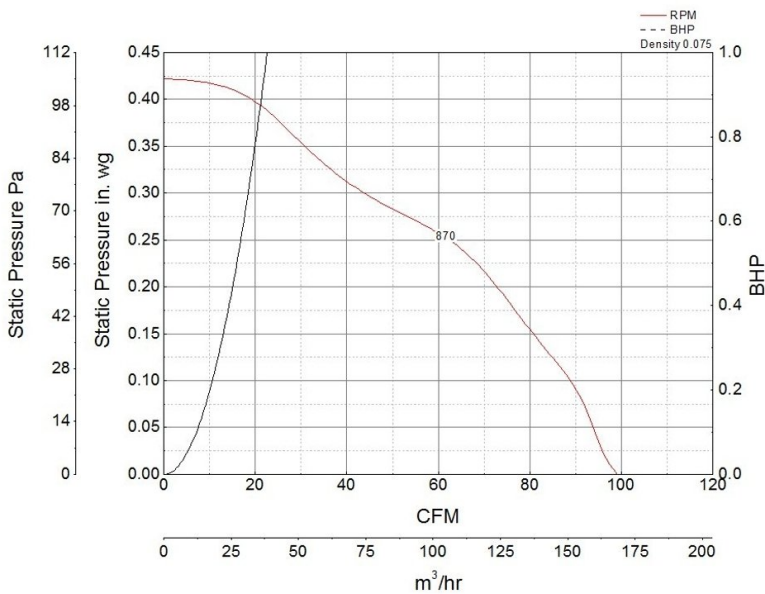

Construction Features

Housing Material	Galvanized Steel
Drive Type	Direct Drive
Impeller Type	Centrifugal Wheel
Impeller Material	Polypropylene
Includes	Backdraft damper Mounting brackets
Certifications	AMCA Air & Sound UL/cUL 507
Speed Controllable	Yes

Motor Information

Motor Insulation	A
Motor Phase	1
Motor Type	PSC
Service Factor	1
Voltage	115
Hertz	60
Motor Enclosure	n/a
RPM	900
Thermal Protection	AutoOverload
Nominal Efficiency	20
Watts	16.7

Air and Sound Performance

Watts	Max Fan RPM	Min Fan RPM	Ps (in. wg)	0	0.125	0.25
16.9	870	696	CFM	114	98	80
			Sones	<0.3	<0.3	0.4



- Greenheck Fan Corporation certifies that the SP models shown herein are licensed to bear the AMCA seal.
- The ratings shown are based on tests and procedures performed in accordance with AMCA Publication 211 and AMCA Publication 311 and comply with the requirements of the AMCA Certified Ratings Program.
- The SP models are not AMCA certified with 50 hertz motors.

California Residents

 **WARNING**

This product can expose you to chemicals including cadmium used in the processing of corrosion resistant metal and fasteners, which is known to the State of California to cause cancer and birth defects or other reproductive harm. For more information visit www.P65Warnings.ca.gov