



SKU
BSQ-180-10X-QD-DR2

Job Name:
Mark:
Submitted By:
Date: 05/04/2026

Square Centrifugal Inline Fan, Product # BSQ-180-10X-QD-DR2, 2925-4840 CFM



Model BSQ centrifugal inline fan features a unique combination of installation flexibility, rugged construction, ease of service, high efficiency and low sound levels. These compact fans are the ideal selection for indoor clean air applications including intake, exhaust, return or make-up air.

- 23.875 x 23.875 inch inlet width x height
- 23.875 x 23.875 inch outlet width x height
- Horizontal or vertical mounting

Certifications

AMCA Sound & Air
UL/cUL 705

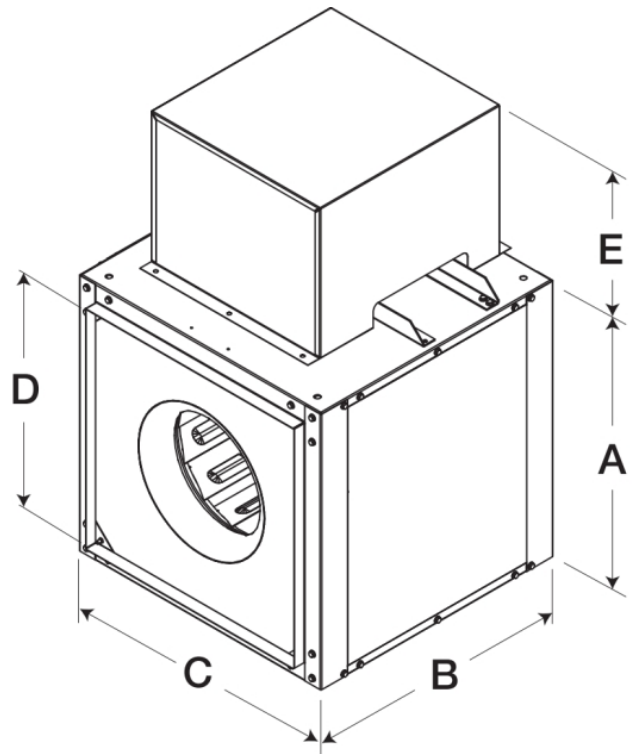

A	B	C	D	E
28 in	28 in	28 in	23.875 in	13.75 in

Performance Characteristics

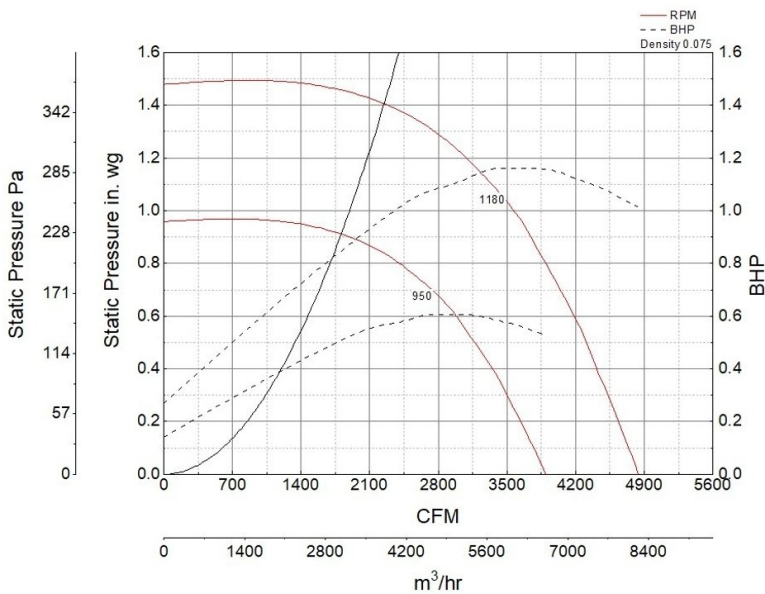

Construction Features

Housing Material	Galvanized Steel
Drive Type	Belt Drive
Impeller Type	Centrifugal Wheel
Impeller Material	Aluminum
Includes	Motor cover Unassembled drive package
Certifications	AMCA Sound & Air UL/cUL 705
Drive Package Description	Motor and drives shipped loose

Motor Information

Motor Insulation	B
Motor Phase	1
Motor Type	NEMA
Service Factor	1.5
Voltage	115/208-230
HP	1
Hertz	60
Motor Enclosure	Open Drip Proof
RPM	1800
Thermal Protection	AutoOverload
Nominal Efficiency	69
NEMA Frame Size	56

Air and Sound Performance

Motor HP	Max BHP	Max Fan RPM	Min Fan RPM	Ps (in. wg)	0	0.125	0.25	0.375	0.5	0.625	0.75	0.875	1	1.25
1	1.16	1180	950	CFM	4,840	4,713	4,582	4,444	4,306	4,147	3,967	3,780	3,554	2,925
				Sones	18.1	17.6	17	16.6	16.2	15.8	15.6	15.7	15.6	14.8



- Greenheck Fan Corporation certifies that the model shown herein is licensed to bear the AMCA Seal. The ratings shown are based on tests and procedures performed in accordance with AMCA Publication 211 and AMCA Publication 311 and comply with the requirements of the AMCA Certified Ratings Program.
- Performance certified is for installation type B: Free inlet, Ducted outlet.
- Power rating (BHP/kW) includes transmission losses.
- Performance ratings do not include the effects of appurtenances (accessories).
- The inlet sound ratings shown are loudness values in fan sones at 5 ft. (1.5 m) in a hemispherical free field calculated per AMCA Standard 301. Values shown are for installation type B: free inlet hemispherical sone levels.

California Residents

 **WARNING**

This product can expose you to chemicals including cadmium used in the processing of corrosion resistant metal and fasteners, which is known to the State of California to cause cancer and birth defects or other reproductive harm. For more information visit www.P65Warnings.ca.gov

 **WARNING**