



SKU
CAD-10-10X10

Job Name:
Mark:
Submitted By:
Date: 04/02/2026

Cam Style Access Door, Product # CAD-10-10X10



Access doors are designed for use in low to medium pressure duct systems. They provide a durable, practical, and inexpensive means of gaining access to damper components inside the ductwork.

- Plated steel latches with galvanized steel strikes
- 9.25 x 9.25 inch recommended duct opening

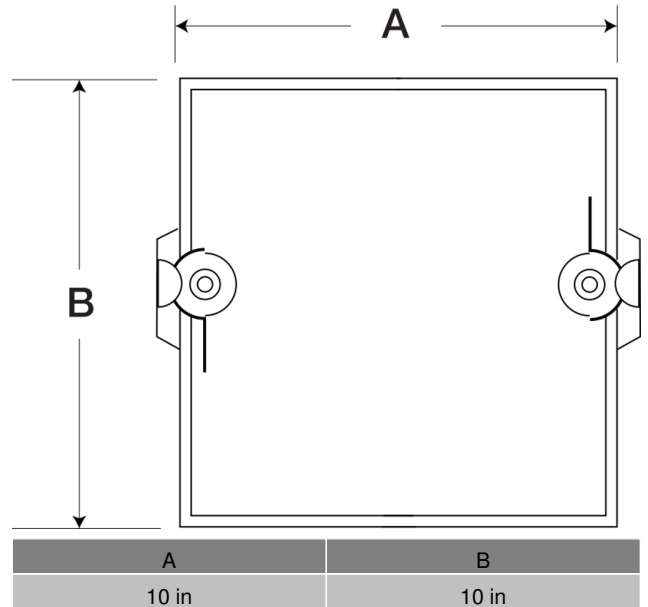

Performance Characteristics

No Fan Curve Available.

Construction Features

Frame Material	Galvanized Steel
Frame Gauge	24
Door Panel Construction	Galvanized Steel
Insulation	1 in fiberglass

California Residents

⚠ WARNING

This product can expose you to chemicals including cadmium used in the processing of corrosion resistant metal and fasteners, which is known to the State of California to cause cancer and birth defects or other reproductive harm. For more information visit www.P65Warnings.ca.gov