

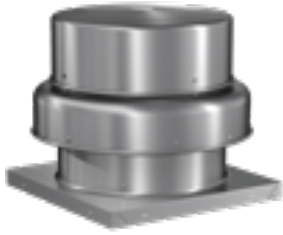

SKU
G-100-B6119XQD

Job Name:
Mark:
Submitted By:
Date: 06/06/2026

Centrifugal Downblast Exhaust Fan, Product # G-100-B6119XQD, 507-966 CFM



Model G, direct drive centrifugal roof exhaust fans provide the industry's best performance and durability for general clean air applications where air is discharged downward, toward the roof. Units feature the most advanced motor cooling of any fan in its class.

- 19 x 19 inch base with prepunched mounting holes for easy attachment to roof curb
- Speed controllable, with up to 30% turndown
- 15.5 x 15.5 inch recommended roof opening

Certifications

AMCA Sound & Air
High Wind and Hurricane
Seismic
UL/cUL 705

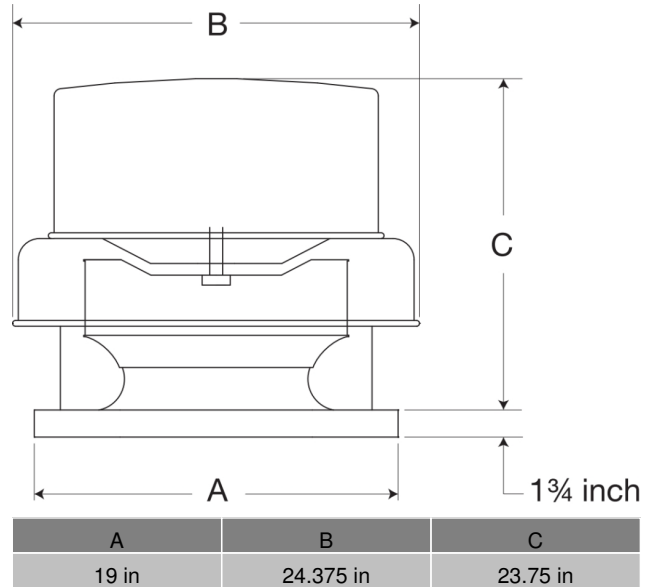

Performance Characteristics

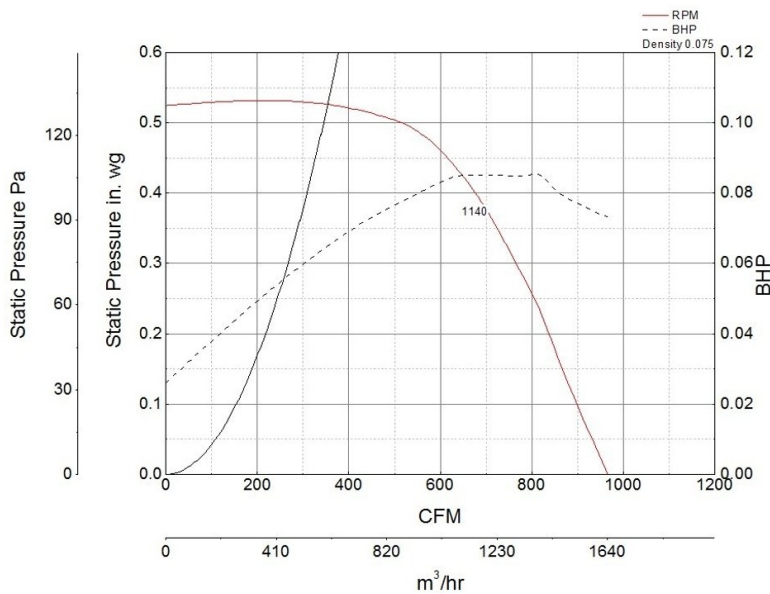

Construction Features

Housing Material	Spun Aluminum
Drive Type	Direct Drive
Impeller Type	Centrifugal Wheel
Impeller Material	Aluminum
Certifications	AMCA Sound & Air High Wind and Hurricane Seismic UL/cUL 705
Speed Controllable	Yes
Required Accessory	Roof curbs for new installations

Motor Information

Motor Insulation	B
Motor Phase	1
Motor Type	NEMA
Service Factor	1
Voltage	115
HP	1/6
Hertz	60
Motor Enclosure	Open Drip Proof
RPM	1200
Thermal Protection	AutoOverload
Nominal Efficiency	49.6
NEMA Frame Size	48

Air and Sound Performance

Motor HP	Max BHP	Max Fan RPM	Min Fan RPM	Ps (in. wg)	0	0.125	0.25	0.375	0.5
1/6	0.09	1140	0	CFM	966	883	805	702	507
				Sones	6.7	6.1	5.8	5.3	4.3



- Greenheck Fan Corporation certifies that the model shown herein is licensed to bear the AMCA Seal. The ratings shown are based on tests and procedures performed in accordance with AMCA Publication 211 and AMCA Publication 311 and comply with the requirements of the AMCA Certified Ratings Program.
- Performance certified is for installation type A: Free inlet, Free outlet.
- Power rating (BHP/kW) does not include transmission losses.
- Performance ratings include the effects of birdscreen.
- The sound ratings shown are loudness values in fan sones at 5 ft. (1.5 m) in a hemispherical free field calculated per AMCA Standard 301. Values shown are for installation type A: free inlet hemispherical sone levels.

California Residents

 **WARNING**

This product can expose you to chemicals including cadmium used in the processing of corrosion resistant metal and fasteners, which is known to the State of California to cause cancer and birth defects or other reproductive harm. For more information visit www.P65Warnings.ca.gov