

Sightproof Louver Drainable Blade

Application and Design

SED-501 is a sightproof weather louver designed to protect air intake and exhaust openings in building exterior walls when visual see through prevention is needed. Design incorporates a drainable head member and drainable horizontal Chevron style blades to channel water to the jambs which guides the water through vertical downspouts for escape at the sill. The SED-501 is an extremely efficient louver with **AMCA LICENSED PERFORMANCE DATA** enabling designers to select and apply with confidence.

Standard Construction

- Frame** Heavy gauge extruded 6063-T5 aluminum, 5 in. x 0.081 in. nominal wall thickness
- Blades** Chevron style drainable design, heavy gauge extruded 6063-T5 aluminum, 0.081 in. nominal wall thickness, positioned on approximately 2 in. centers
- Construction** . . . Mechanically fastened
- Birdscreen** 3/4 in. x 0.051 in. flattened expanded aluminum in removable frame, inside mount (rear)
- Finish** Mill
- Minimum Size** . . 12 in. W x 12 in. H
- Maximum Single Section Size** . . . 120 in. W or 120 in. H (limited to 70 ft. sq.)

Options (at additional cost)

- A variety of bird and insect screens
- Blank off panel
- Extended sill
- Filter rack
- Flanged frame
- Hinged frame
- Security bars
- A variety of architectural finishes including:
 - Clear anodize
 - Integral color anodize
 - Baked enamel paint
 - Kynar paint

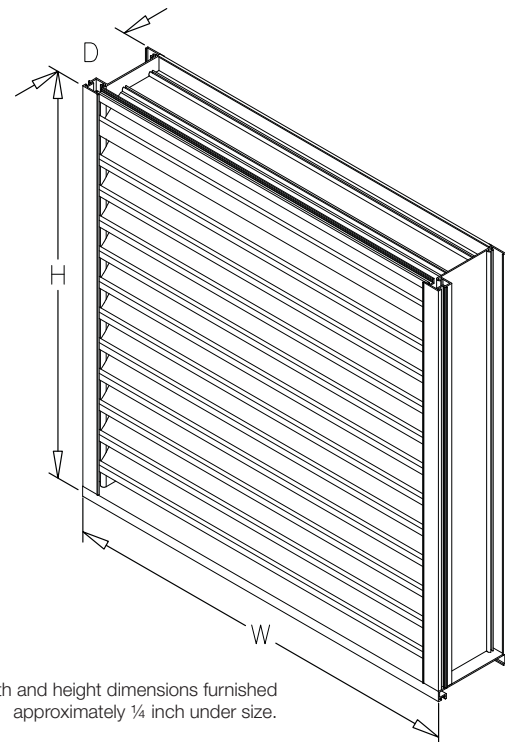
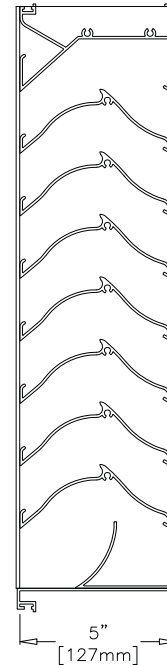

*Width and height dimensions furnished approximately 1/4 inch under size.

PERFORMANCE DATA

SED-501

Sightproof Louver Drainable Blade
Extruded Aluminum

Free Area Chart (Sq. ft.)

Louver Height Inches	Louver Width in Inches												
	12	24	30	42	48	60	66	78	84	96	102	114	120
12	0.32	0.74	0.95	1.37	1.58	1.95	2.16	2.57	2.78	3.20	3.41	3.83	3.99
18	0.58	1.33	1.71	2.46	2.84	3.49	3.87	4.62	5.00	5.75	6.12	6.88	7.16
24	0.84	1.92	2.46	3.55	4.09	5.04	5.58	6.67	7.21	8.30	8.84	9.92	10.33
30	1.09	2.51	3.22	4.64	5.35	6.59	7.30	8.71	9.42	10.84	11.55	12.97	13.50
36	1.35	3.10	3.98	5.73	6.60	8.13	9.01	10.76	11.64	13.39	14.26	16.01	16.67
42	1.61	3.69	4.73	6.82	7.86	9.68	10.72	12.81	13.85	15.93	16.98	19.06	19.84
48	1.86	4.28	5.49	7.91	9.11	11.23	12.44	14.85	16.06	18.48	19.69	22.10	23.01
54	2.12	4.87	6.24	8.99	10.37	12.78	14.15	16.90	18.28	21.03	22.40	25.15	26.18
60	2.38	5.46	7.00	10.08	11.63	14.32	15.86	18.95	20.49	23.57	25.11	28.20	29.35
66	2.63	6.05	7.76	11.17	12.88	15.87	17.58	20.99	22.70	26.12	27.83	31.24	32.52
72	2.89	6.64	8.51	12.26	14.14	17.42	19.29	23.04	24.91	28.66	30.51	34.29	35.69
78	3.15	7.23	9.27	13.35	15.39	18.96	21.00	25.09	27.13	31.21	33.25	37.33	38.86
84	3.40	7.82	10.03	14.44	16.65	20.51	22.72	27.13	29.34	33.76	35.96	40.38	42.03
90	3.66	8.41	10.78	15.53	17.90	22.06	24.43	29.18	31.55	36.30	38.68	43.42	45.20
96	3.92	9.00	11.54	16.62	19.16	23.61	26.15	31.23	33.78	38.85	41.39	46.47	48.37
102	4.17	9.59	12.29	17.71	20.41	25.15	27.86	33.27	35.98	41.39	44.10	49.51	51.54
108	4.43	10.18	13.05	18.80	21.67	26.70	29.57	35.32	38.19	43.94	46.81	52.56	54.72
114	4.69	10.77	13.81	19.89	22.93	28.25	31.29	37.37	40.41	43.49	49.53	55.61	57.89
120	4.94	11.36	14.56	20.98	24.18	29.79	33.00	39.41	42.62	49.03	52.24	58.65	61.06



Greenheck Fan Corporation certifies that the SED-501 louvers shown herein are licensed to bear the AMCA Seal. The ratings shown are based on tests and procedures performed in accordance with AMCA Publication 511 and comply with the requirements of the AMCA Certified Ratings Program. The AMCA Certified Ratings Seal applies to air performance and water penetration ratings.

Airflow Resistance (Standard Air - .075 lb/ft³)

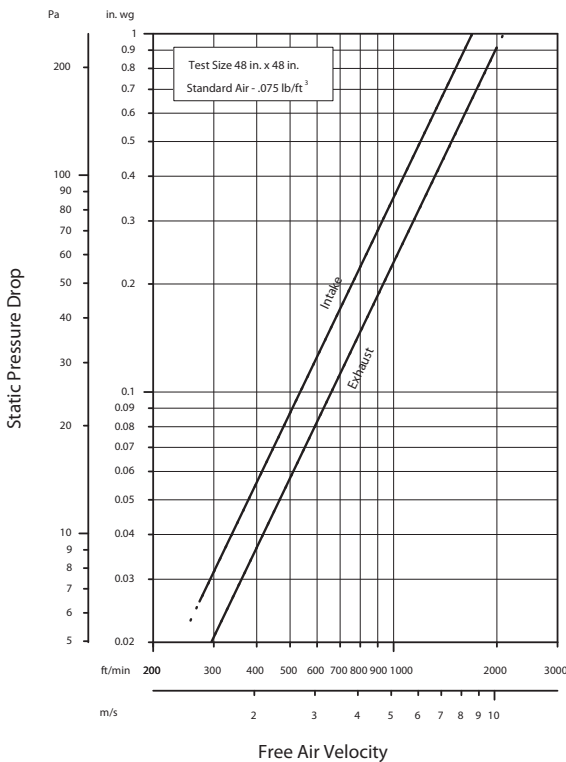

Model SED-501 resistance to airflow (pressure drop) varies depending on louver application (air intake or air exhaust). Free area velocities (shown) are higher than average velocity through the overall louver size. See louver selection information.

Water Penetration (Standard Air - .075 lb/ft³)

Test size 48 in. x 48 in. Test duration of 15 min.

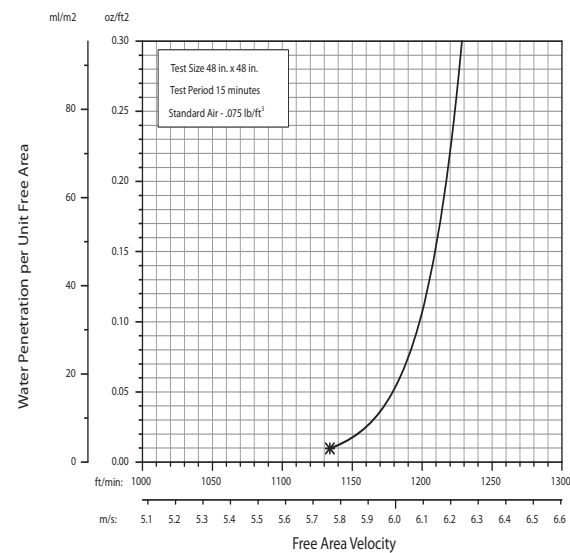

The AMCA Water Penetration Test provides a method for comparing various louver models and designs as to their efficiency in resisting the penetration of rainfall under specific laboratory test conditions. The beginning point of water penetration is defined as that velocity where the water penetration curve projects through .01 oz. of water (penetration) per sq. ft. of louver free area. ***The beginning point of water penetration for Model SED-501 is 1134 fpm free area velocity.** These performance ratings do not guarantee a louver to be weatherproof or stormproof and should be used in combination with other factors including good engineering judgement in selecting louvers.



INSTALLATION DETAILS

SED-501

Maximum Size and Installation Information

Sightproof Louver Drainable Blade
Extruded Aluminum

Maximum single section size for model SED-501 is 120 in. W x 84 in. H or 84 in. W x 120 in. H (70 sq. ft). Larger openings require field assembly of multiple louver panels to make up the overall opening size. Individual louver panels are designed to withstand a 25 PSF wind-load (please consult Greenheck if the louvers must withstand higher wind-loads). Structural reinforcing members may be required to adequately support and install multiple louver panels within a large opening. Structural reinforcing members along with any associated installation hardware is not provided by Greenheck unless indicated otherwise by Greenheck. Additional information on louver installation may be found in AMCA Publication #501, Louver Application Manual.

SINGLE SECTION
W/ SUPPORT ANGLES

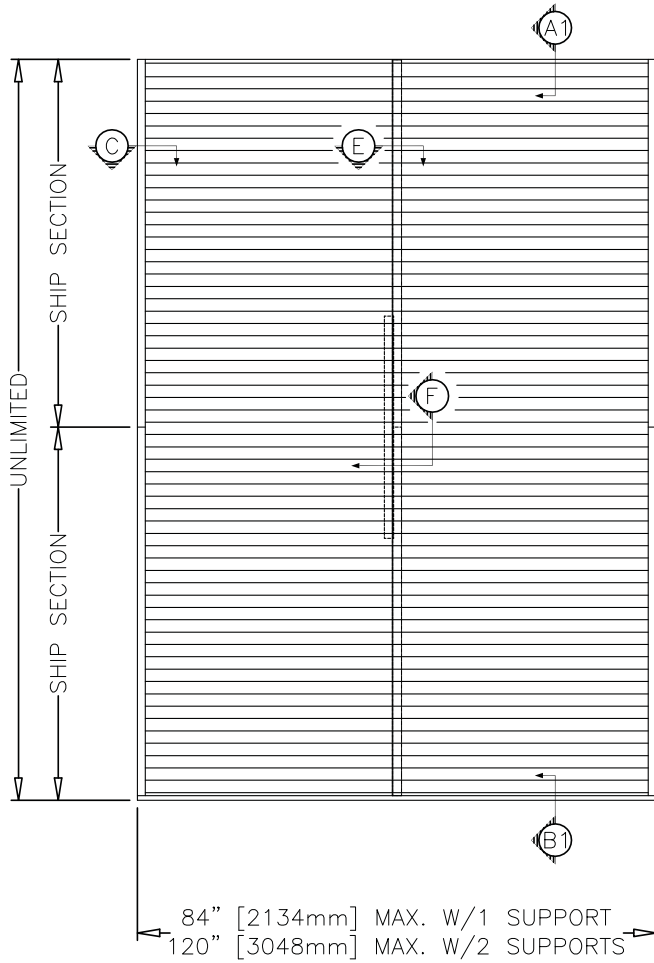

MULTIPLE SECTION W/ MULLION

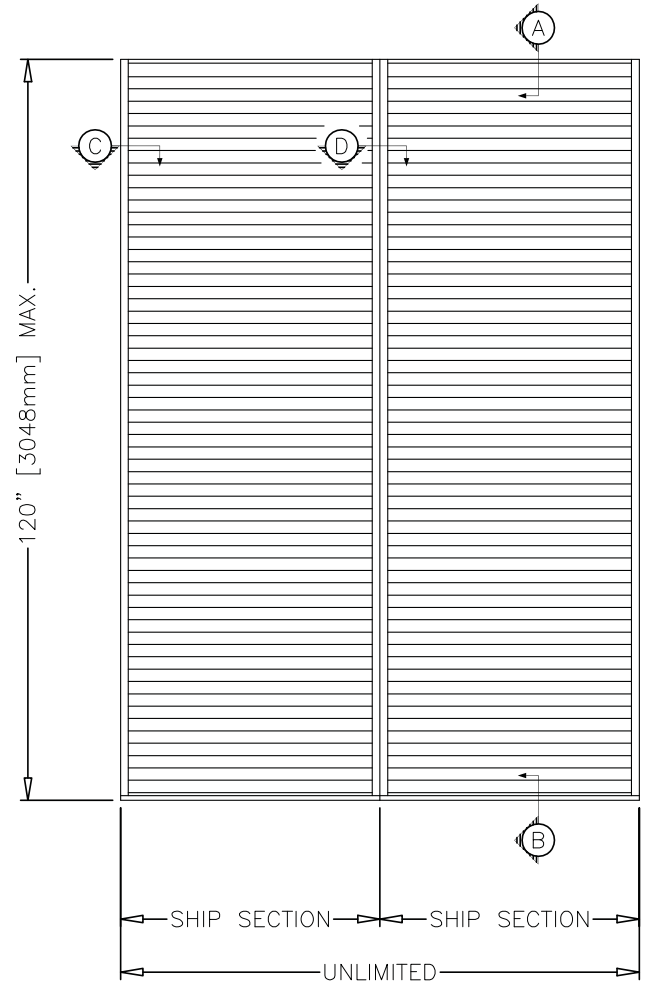

Minimum Single Section Size

12 in. W x 12 in. H

Maximum Single Section Size

70 ft. sq.

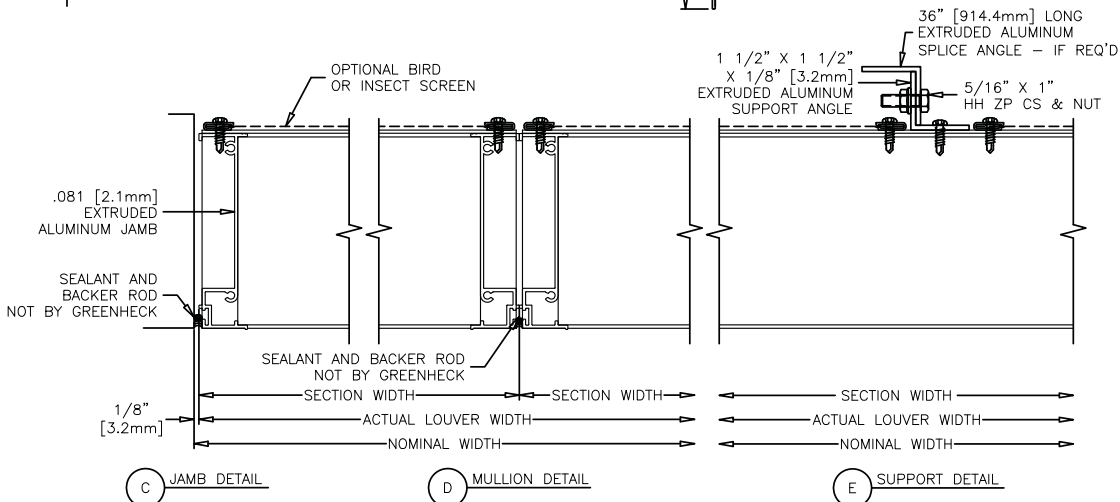
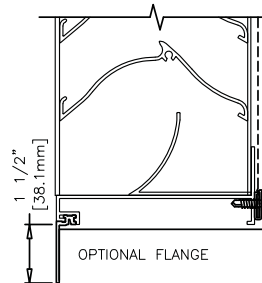
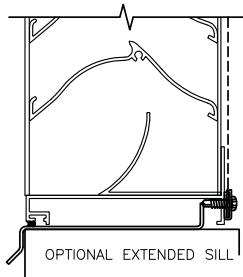
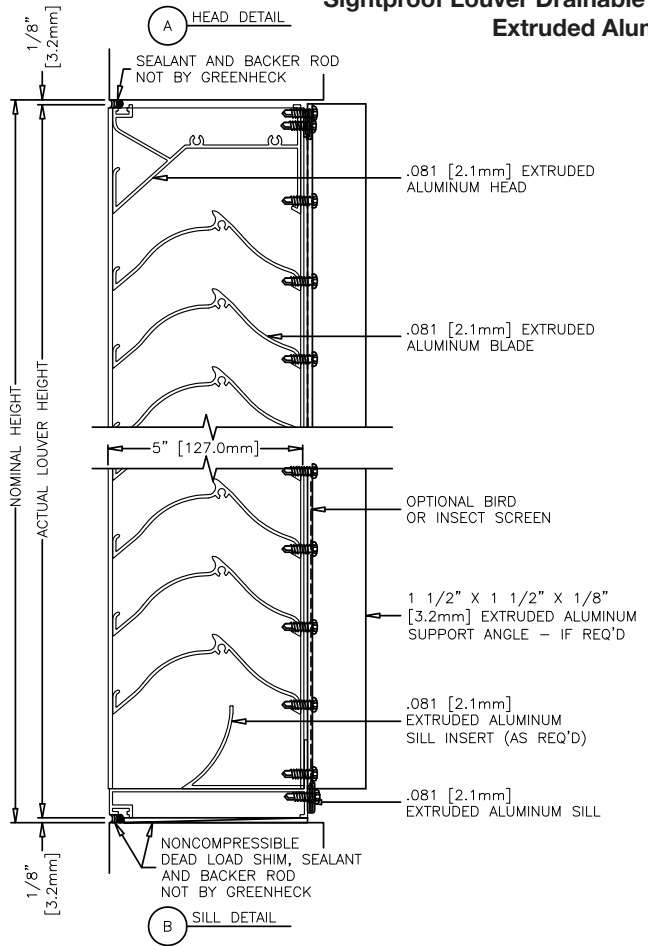
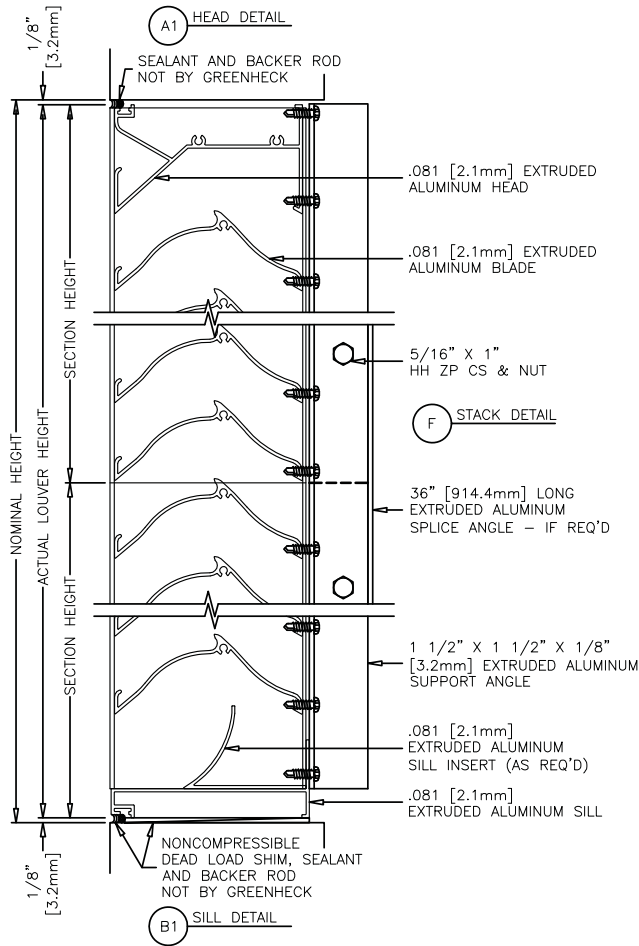

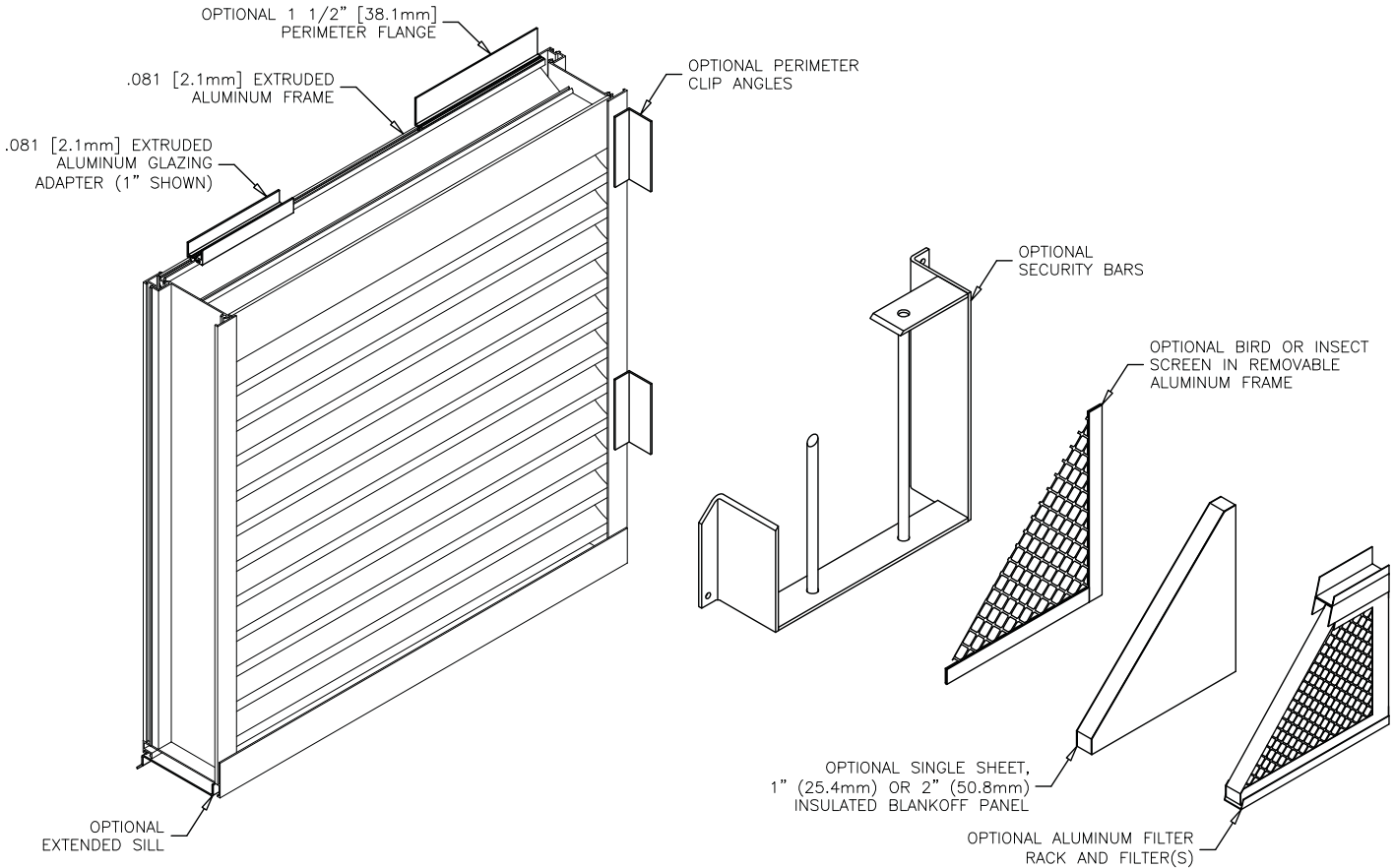

FINISHES

Finish Type	Description/Application	Color Selection	Standard Warranty (Aluminum)
2-coat 70% KYNAR 5000®/HYLAR 5000® AAMA 2605 – Dry film thickness 1.2 mil. (AKA: Duranar®, Fluoropon®, Trinar®, Fluoropolymer, Polyvinylidene Fluoride, PVDF2)	"Best." The premier finish for extruded aluminum. Tough, long-lasting coating has superior color retention and abrasive properties. Resists chalking, fading, chemical abrasion and weathering.	Standard Colors: Any of the 24 standard colors shown can be furnished in 70% or 50% KYNAR 5000®/HYLAR 5000® or Baked Enamel. 2-Coat Mica: Greenheck offers 9 standard 2-coat Mica colors. Other colors are available. Consult Greenheck for possible extra cost when selecting non-standard colors or special finishes.	10 Years (Consult Greenheck for availability of extended warranty)
2-coat 50% KYNAR 5000®/HYLAR 5000® AAMA 2604 – Dry film thickness 1.2 mil. (AKA: Acroflur®, Acrynar®)	"Better." Tough, long-lasting coating has excellent color retention and abrasive properties. Resists chalking, fading, chemical abrasion and weathering.		5 Years
Baked Enamel AAMA 2603 – Dry film thickness 0.8 mil. (AKA: Acrabond Plus®, Duracron®)	"Good." Provides good adhesion and resistance to weathering, corrosion and chemical stain.		1 Year
Integral Color Anodize AA-M10C22A42 (>0.7 mil)	"Two-step" anodizing is produced by following the normal anodizing step with a second, colorfast process.	Light, Medium or Dark Bronze; Champagne; Black	5 years
Clear Anodize 215 R-1 AA-M10C22A41 (>0.7 mil)	Clear, colorless and hard oxide aluminum coating that resists weathering and chemical attack.	Clear	5 years
Clear Anodize 204 R-1 AA-M10C22A31 (0.4-0.7 mil)	Clear, colorless and hard oxide aluminum coating that resists weathering and chemical attack.	Clear	1 Year
Industrial coatings	Greenheck offers a number of industrial coatings such as Hi-Pro Polyester, Epoxy, and Permatector®. Consult a Greenheck Product Specialist for complete color and application information.		Consult Greenheck
Mill	Materials may be supplied in natural aluminum or galvanized steel finish when normal weathering is acceptable and there is no concern for color or color change.		n/a

Finishes meet or exceed AAMA 2605, AAMA 2604, and AAMA 2603 requirements. Please consult www.greenheck.com for complete information on standard and extended paint warranties. Paint finish warranties are not applicable to steel products.

