

Thinline Louver Frameless

Application and Design

ESU-153S is a frameless ultra thinline stationary louver commonly used for interior or exterior applications where high free area and low airflow resistance is required. The narrow depth makes this product ideal for installation into thru-wall air conditioning units.

Standard Construction

FrameFrameless

BladesThinline style, heavy gauge 5052-H32 aluminum,
0.050 in. nominal wall thickness, positioned at 30°
angles on approximately 3/4 in. centers

Construction . . .Mechanically fastened

FinishMill

Minimum Size . . 12 1/2 in. W x 6 in. H

Maximum Single

Section Size . . .96 in. W x 48 in. H

Options *(at additional cost)*

- A variety of architectural finishes including:
 - Clear anodize
 - Integral color anodize
 - Baked enamel paint
 - Kynar paint

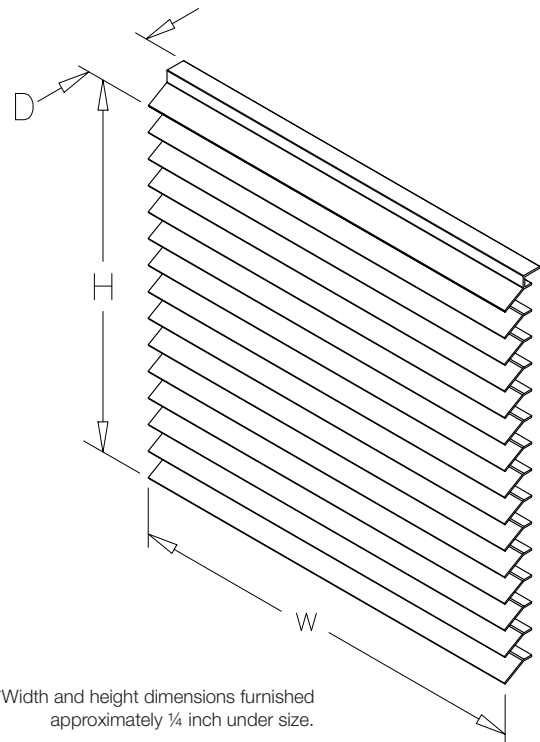
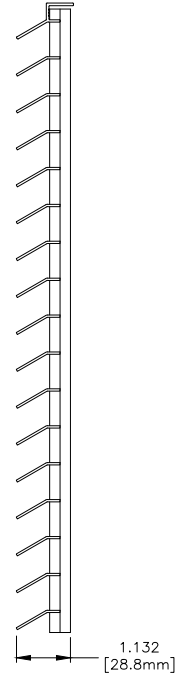

*Width and height dimensions furnished approximately 1/4 inch under size.

PERFORMANCE DATA

ESU-153S

Thinline Louver
Aluminum

Free Area Chart (Sq. ft.)

Louver Height Inches	Louver Width in Inches															
	10	12	18	24	30	36	42	48	54	60	66	72	78	84	90	96
10	0.42	0.52	0.84	1.10	1.42	1.73	1.99	2.31	2.57	2.89	3.20	3.46	3.78	4.04	4.35	4.67
12	0.51	0.64	1.02	1.34	1.72	2.10	2.42	2.80	3.12	3.50	3.88	4.20	4.58	4.90	5.28	5.66
14	0.59	0.74	1.19	1.56	2.01	2.45	2.82	3.27	3.64	4.09	4.53	4.91	5.35	5.72	6.17	6.62
16	0.69	0.86	1.38	1.81	2.32	2.84	3.27	3.79	4.22	4.74	5.25	5.68	6.20	6.63	7.15	7.66
18	0.77	0.97	1.55	2.03	2.61	3.20	3.68	4.26	4.74	5.33	5.91	6.39	6.97	7.46	8.04	8.62
20	0.87	1.09	1.74	2.28	2.93	3.58	4.13	4.78	5.32	5.97	6.62	7.17	7.82	8.36	9.01	9.67
22	0.95	1.19	1.91	2.51	3.22	3.94	4.53	5.25	5.85	6.56	7.28	7.88	8.59	9.19	9.90	10.62
24	1.04	1.30	2.08	2.73	3.51	4.29	4.94	5.72	6.37	7.15	7.93	8.58	9.36	10.01	10.79	11.57
26	1.13	1.42	2.27	2.98	3.83	4.68	5.39	6.24	6.95	7.80	8.65	9.36	10.21	10.92	11.77	12.62
28	1.22	1.53	2.44	3.20	4.12	5.03	5.80	6.71	7.47	8.39	9.31	10.07	10.98	11.75	12.66	13.58
30	1.31	1.64	2.63	3.45	4.44	5.42	6.24	7.23	8.05	9.04	10.02	10.85	11.83	12.65	13.64	14.63
32	1.40	1.75	2.80	3.68	4.73	5.78	6.65	7.70	8.58	9.63	10.68	11.55	12.60	13.48	14.53	15.58
34	1.49	1.86	2.98	3.91	5.03	6.15	7.08	8.20	9.13	10.25	11.37	12.30	13.42	14.35	15.47	16.59
36	1.58	1.98	3.16	4.15	5.33	6.52	7.51	8.69	9.68	10.87	12.05	13.04	14.22	15.21	16.40	17.58
38	1.67	2.08	3.33	4.37	5.62	6.87	7.91	9.16	10.21	11.45	12.70	13.75	15.00	16.04	17.29	18.54
40	1.76	2.20	3.52	4.62	5.94	7.26	8.36	9.68	10.78	12.10	13.42	14.52	15.84	16.94	18.26	19.58
42	1.85	2.31	3.69	4.85	6.23	7.62	8.77	10.15	11.31	12.69	14.08	15.23	16.62	17.77	19.15	20.54
44	1.94	2.43	3.88	5.09	6.55	8.00	9.22	10.67	11.88	13.34	14.80	16.01	17.46	18.68	20.13	21.59
46	2.03	2.53	4.05	5.32	6.84	8.36	9.62	11.14	12.41	13.93	15.45	16.72	18.24	19.50	21.02	22.54
48	2.12	2.65	4.23	5.56	7.14	8.73	10.06	11.64	12.97	14.55	16.14	17.47	19.05	20.38	21.96	23.55

Airflow Resistance (Standard Air - .075 lb/ft³)

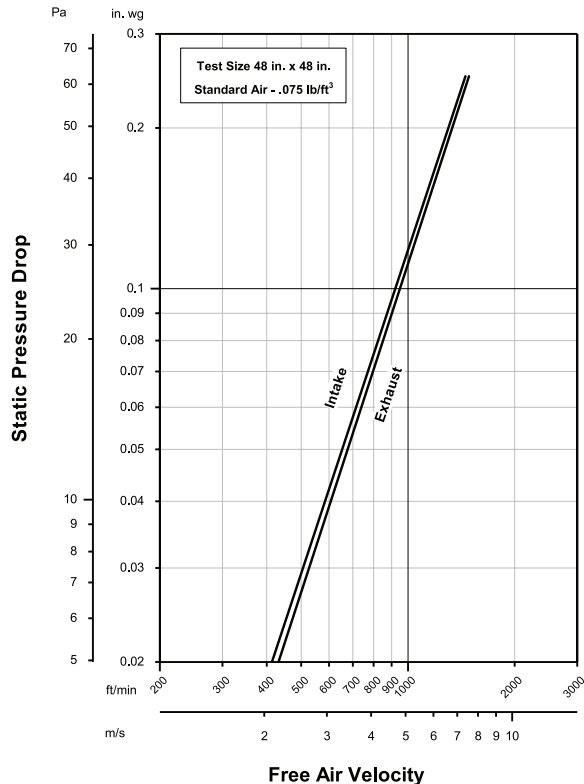

Model ESU-153S resistance to airflow (pressure drop) varies depending on louver application (air intake or air exhaust). Free area velocities (shown) are higher than average velocity through the overall louver size. See louver selection information.

INSTALLATION DETAILS

ESU-153S

Thinline Louver
Aluminum

Maximum Size and Installation Information

Maximum single section size for model ESU-153S is 96 in. W x 48 in. H. Larger openings require field assembly of multiple louver panels to make up the overall opening size. Individual louver panels are designed to withstand a 25 PSF wind-load (please consult Greenheck if the louvers must withstand higher wind-loads). Structural reinforcing members may be required to adequately support and install multiple louver panels within a large opening. Structural reinforcing members along with any associated installation hardware is not provided by Greenheck unless indicated otherwise by Greenheck. Additional information on louver installation may be found in AMCA Publication #501, Louver Application Manual.

SINGLE SECTION

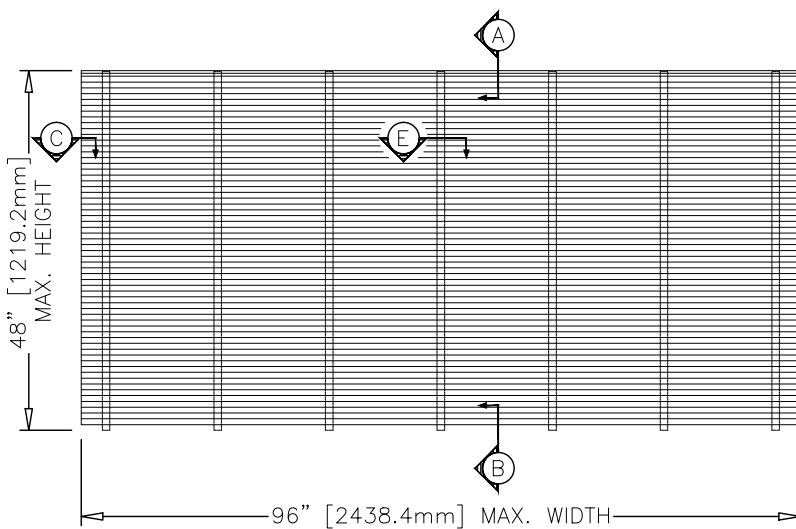

MULTIPLE SECTION W/ MULLION

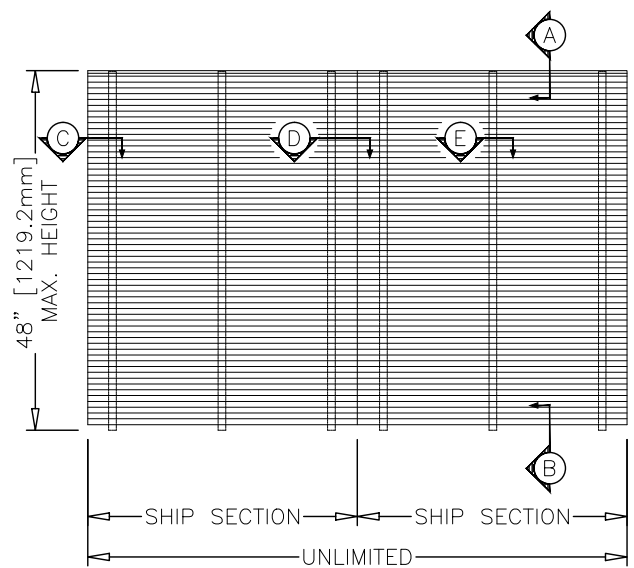

Minimum Single Section Size

12 ½ in. W x 6 in. H

Maximum Single Section Size

96 in. W x 48 in. H

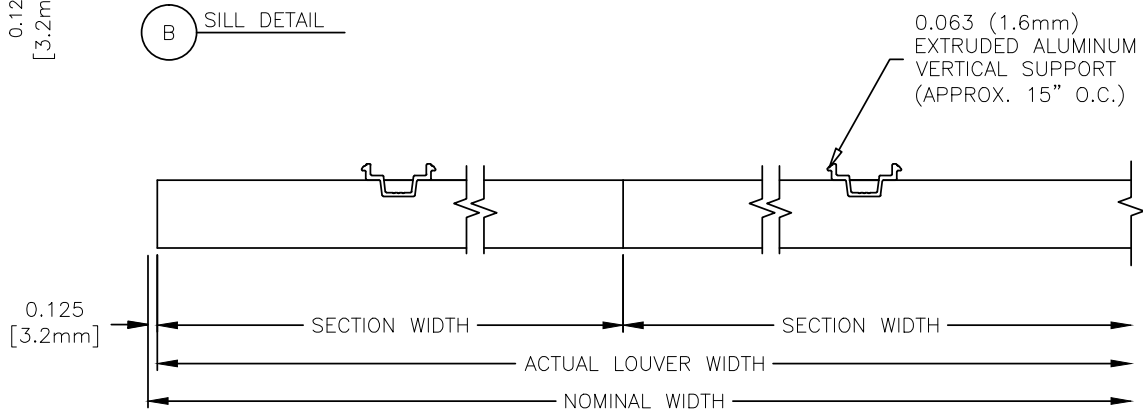
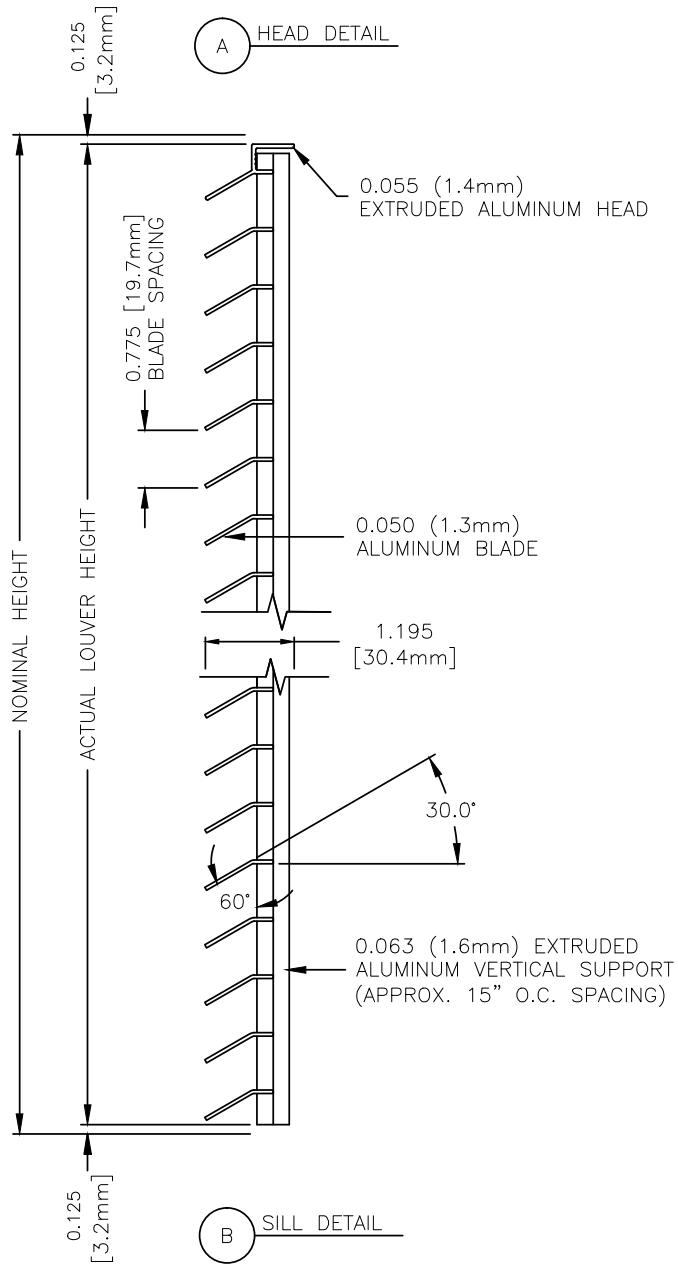

C JAMB DETAIL

D MULLION DETAIL

E SUPPORT DETAIL

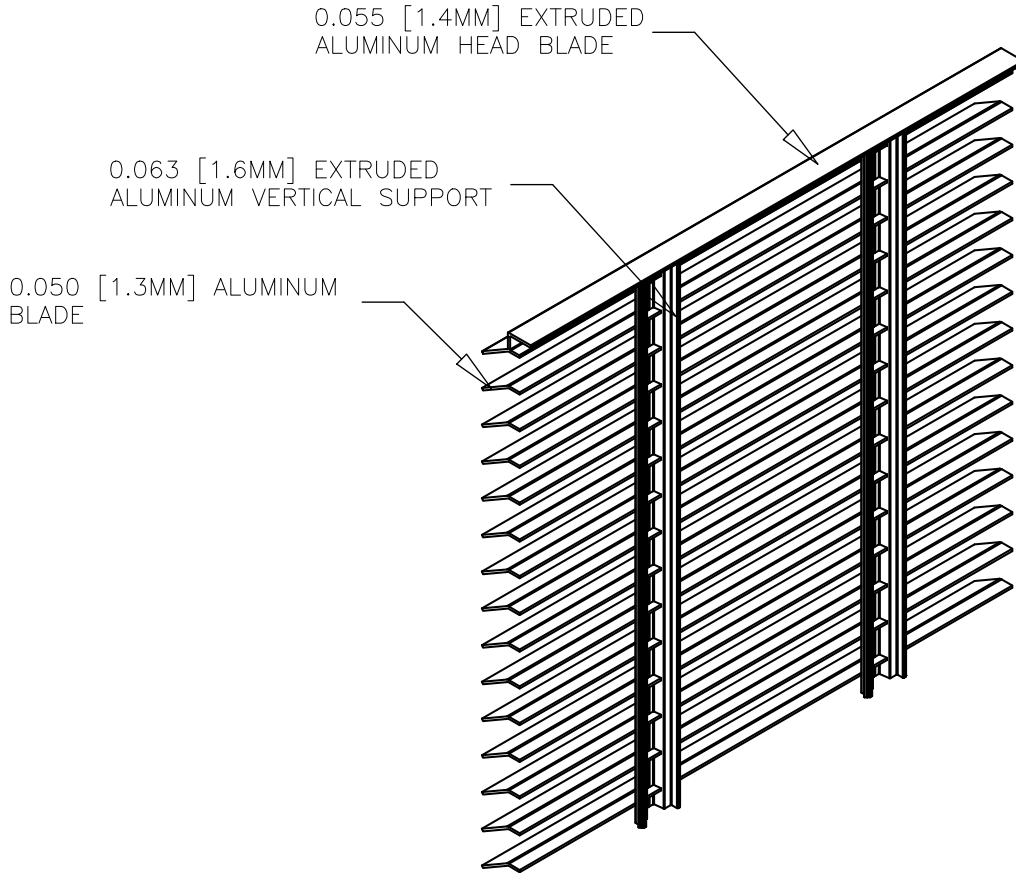

FINISHES

Finish Type	Description/Application	Color Selection	Standard Warranty (Aluminum)
2-coat 70% KYNAR 5000®/HYLAR 5000® AAMA 2605 – Dry film thickness 1.2 mil. (AKA: Duranar®, Fluoropon®, Trinar®, Fluoropolymer, Polyvinylidene Fluoride, PVDF2)	“Best.” The premier finish for aluminum. Tough, long-lasting coating has superior color retention and abrasive properties. Resists chalking, fading, chemical abrasion and weathering.	Standard Colors: Any of the 24 standard colors shown can be furnished in 70% or 50% KYNAR 500®/HYLAR 5000® or Baked Enamel. 2-Coat Mica: Greenheck offers 9 standard 2-coat Mica colors. Other colors are available. Consult Greenheck for possible extra cost when selecting non-standard colors or special finishes.	10 Years (Consult Greenheck for availability of extended warranty)
2-coat 50% KYNAR 500®/HYLAR 5000® AAMA 2604 – Dry film thickness 1.2 mil. (AKA: Acroflur®, Acrynar®)	“Better.” Tough, long-lasting coating has excellent color retention and abrasive properties. Resists chalking, fading, chemical abrasion and weathering.		5 Years
Baked Enamel AAMA 2603 – Dry film thickness 0.8 mil. (AKA: Acrabond Plus®, Duracron®)	“Good.” Provides good adhesion and resistance to weathering, corrosion and chemical stain.		1 Year
Integral Color Anodize AA-M10C22A42 (>0.7 mil)	“Two-step” anodizing is produced by following the normal anodizing step with a second, colorfast process.	Light, Medium or Dark Bronze; Champagne; Black	5 years
Clear Anodize 215 R-1 AA-M10C22A41 (>0.7 mil)	Clear, colorless and hard oxide aluminum coating that resists weathering and chemical attack.	Clear	5 years
Clear Anodize 204 R-1 AA-M10C22A31 (0.4-0.7 mil)	Clear, colorless and hard oxide aluminum coating that resists weathering and chemical attack.	Clear	1 Year
Industrial coatings	Greenheck offers a number of industrial coatings such as Hi-Pro Polyester, Epoxy, and Permatector®. Consult a Greenheck Product Specialist for complete color and application information.		Consult Greenheck
Mill	Materials may be supplied in natural aluminum or galvanized steel finish when normal weathering is acceptable and there is no concern for color or color change.		n/a

Finishes meet or exceed AAMA 2605, AAMA 2604, and AAMA 2603 requirements. Please consult www.greenheck.com for complete information on standard and extended paint warranties. Paint finish warranties are not applicable to steel products.

