

## Stationary Louver J Blade

### Application and Design

ESJ-401LT is a weather louver designed to protect air intake and exhaust openings in building exterior walls. Design incorporates J style blades, sloped sill and high free area to provide maximum resistance to rain and weather while providing minimum resistance to airflow. The ESJ-401LT is an extremely efficient louver with **AMCA LICENSED PERFORMANCE DATA** enabling designers to select and apply with confidence.

### Standard Construction

**Frame** . . . . . Heavy gauge extruded 6063-T5 aluminum, 4 in. x 0.063 in. nominal wall thickness

**Blades** . . . . . J style, heavy gauge extruded 6063-T5 aluminum, 0.063 in. nominal wall thickness, positioned at 37° and 45° angles on approximately 4 in. centers

**Construction** . . . Mechanically fastened

**Birdscreen** . . . . 3/4 in. x 0.051 in. flattened expanded aluminum in removable frame, inside mount (rear)

**Finish** . . . . . Mill

**Minimum Size** . . 12 in. W x 10 in. H

**Maximum Single**

**Section Size** . . . 60 in. W x 60 in. H.

### Options (at additional cost)

- A variety of bird and insect screens
- Blank off panel
- Clip angles
- Extended sill
- Filter rack
- Flanged frame
- Hinged frame
- Security bars
- A variety of architectural finishes including:
  - Clear anodize
  - Integral color anodize
  - Baked enamel paint
  - Kynar paint

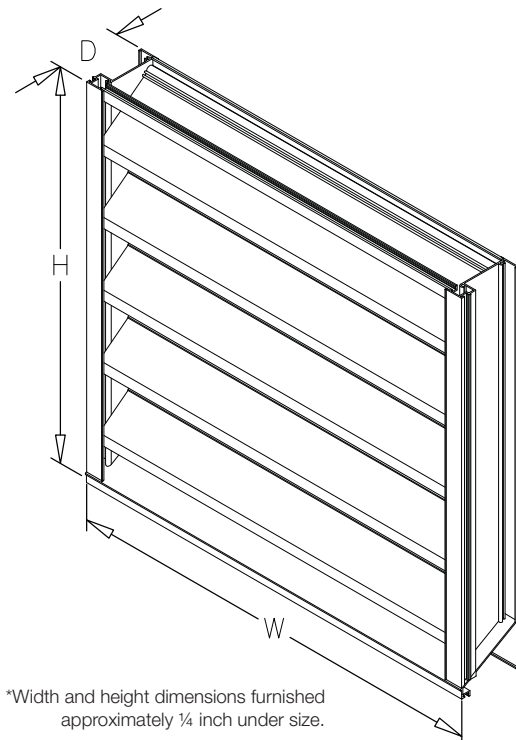
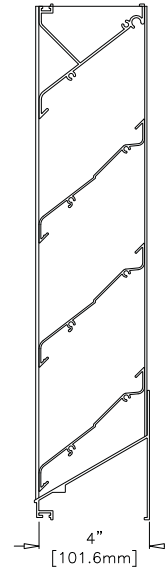

\*Width and height dimensions furnished approximately 1/4 inch under size.

# PERFORMANCE DATA

# ESJ-401LT

Stationary Louver J Blade  
Extruded Aluminum

## Free Area Chart (Sq. ft.)

Height in Inches	Width in Inches								
	12	18	24	30	36	42	48	54	60
12	0.29	0.49	0.68	0.87	1.06	1.25	1.44	1.58	1.77
18	0.54	0.89	1.24	1.59	1.94	2.29	2.64	2.91	3.26
24	0.75	1.24	1.73	2.22	2.71	3.20	3.69	4.05	4.54
30	1.01	1.67	2.32	2.98	3.63	4.29	4.94	5.43	6.09
36	1.26	2.07	2.89	3.70	4.51	5.33	6.14	6.76	7.57
42	1.47	2.42	3.38	4.33	5.28	6.23	7.19	7.90	8.85
48	1.73	2.85	3.96	5.08	6.20	7.32	<b>8.44</b>	9.28	10.40
54	1.97	3.25	4.53	5.81	7.09	8.37	9.64	10.60	11.88
60	2.18	3.60	5.02	6.44	7.85	9.27	10.69	11.75	13.17



Greenheck Fan Corporation certifies that the ESJ-401LT louvers shown herein are licensed to bear the AMCA Seal. The ratings shown are based on tests and procedures performed in accordance with AMCA Publication 511 and comply with the requirements of the AMCA Certified Ratings Program. The AMCA Certified Ratings Seal applies to air performance and water penetration ratings.

## Airflow Resistance (Standard Air - .075 lb/ft<sup>3</sup>)

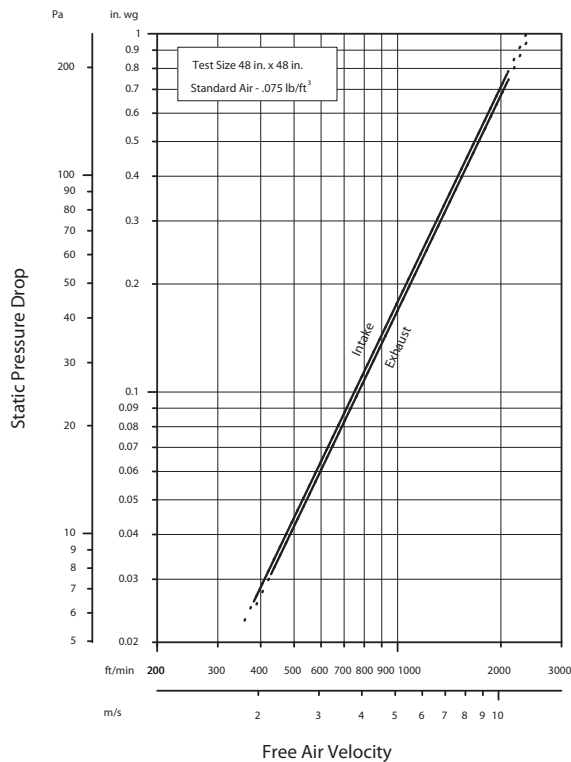

Model ESJ-401LT resistance to airflow (pressure drop) varies depending on louver application (air intake or air exhaust). Free area velocities (shown) are higher than average velocity through the overall louver size. See louver selection information.

## Water Penetration (Standard Air - .075 lb/ft<sup>3</sup>)

Test size 48 in. x 48 in. Test duration of 15 min.

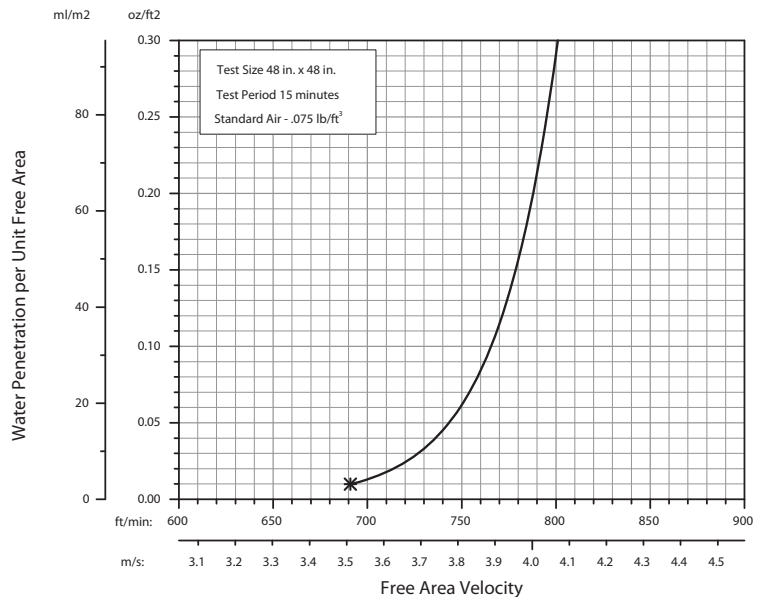

The AMCA Water Penetration Test provides a method for comparing various louver models and designs as to their efficiency in resisting the penetration of rainfall under specific laboratory test conditions. The beginning point of water penetration is defined as that velocity where the water penetration curve projects through .01 oz. of water (penetration) per sq. ft. of louver free area. **\*The beginning point of water penetration for Model ESJ-401LT is 691 fpm free area velocity.** These performance ratings do not guarantee a louver to be weatherproof or stormproof and should be used in combination with other factors including good engineering judgement in selecting louvers.

# INSTALLATION DETAILS

# ESJ-401LT

Stationary Louver J Blade  
Extruded Aluminum

## Maximum Size and Installation Information

Maximum single section size for model ESJ-401LT is 60 in. W x 60 in. H. Individual louver panels are designed to withstand a 25 PSF wind-load (please consult Greenheck if the louvers must withstand higher wind-loads). Structural reinforcing members along with any associated installation hardware is not provided by Greenheck unless indicated otherwise by Greenheck. Additional information on louver installation may be found in AMCA Publication #501, Louver Application Manual.

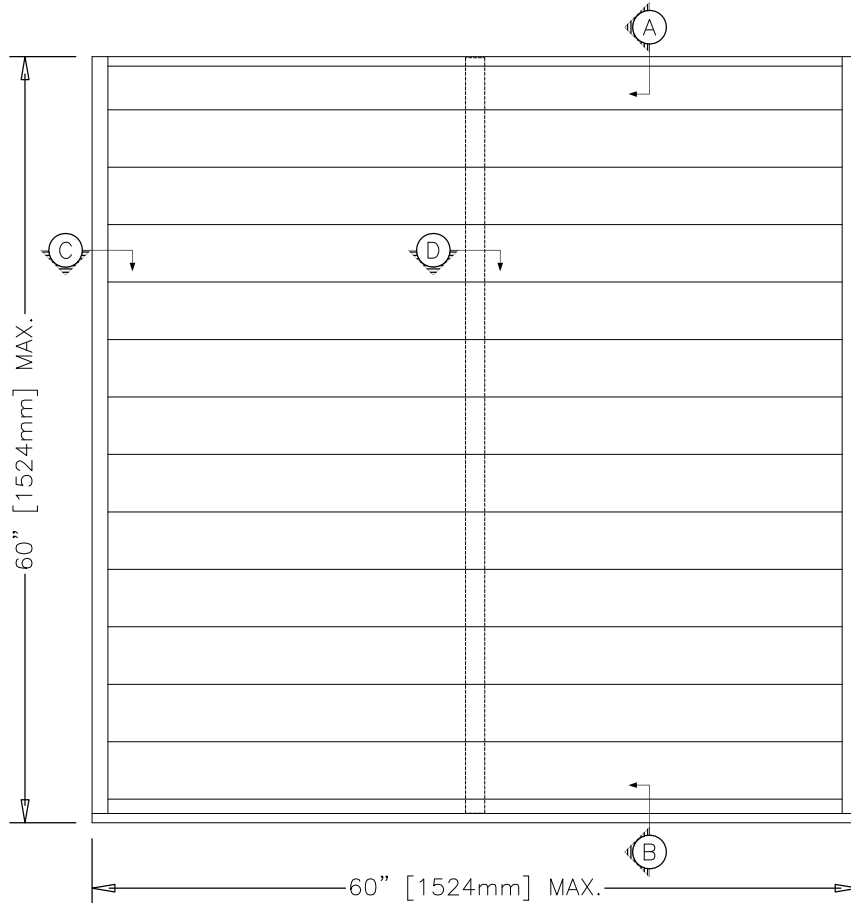

**Minimum Single Section Size**  
12 in. W x 10 in. H

**Maximum Single Section Size**  
60 in. W x 60 in. H

# PRODUCT DETAILS

# ESJ-401LT

Stationary Louver J Blade  
Extruded Aluminum

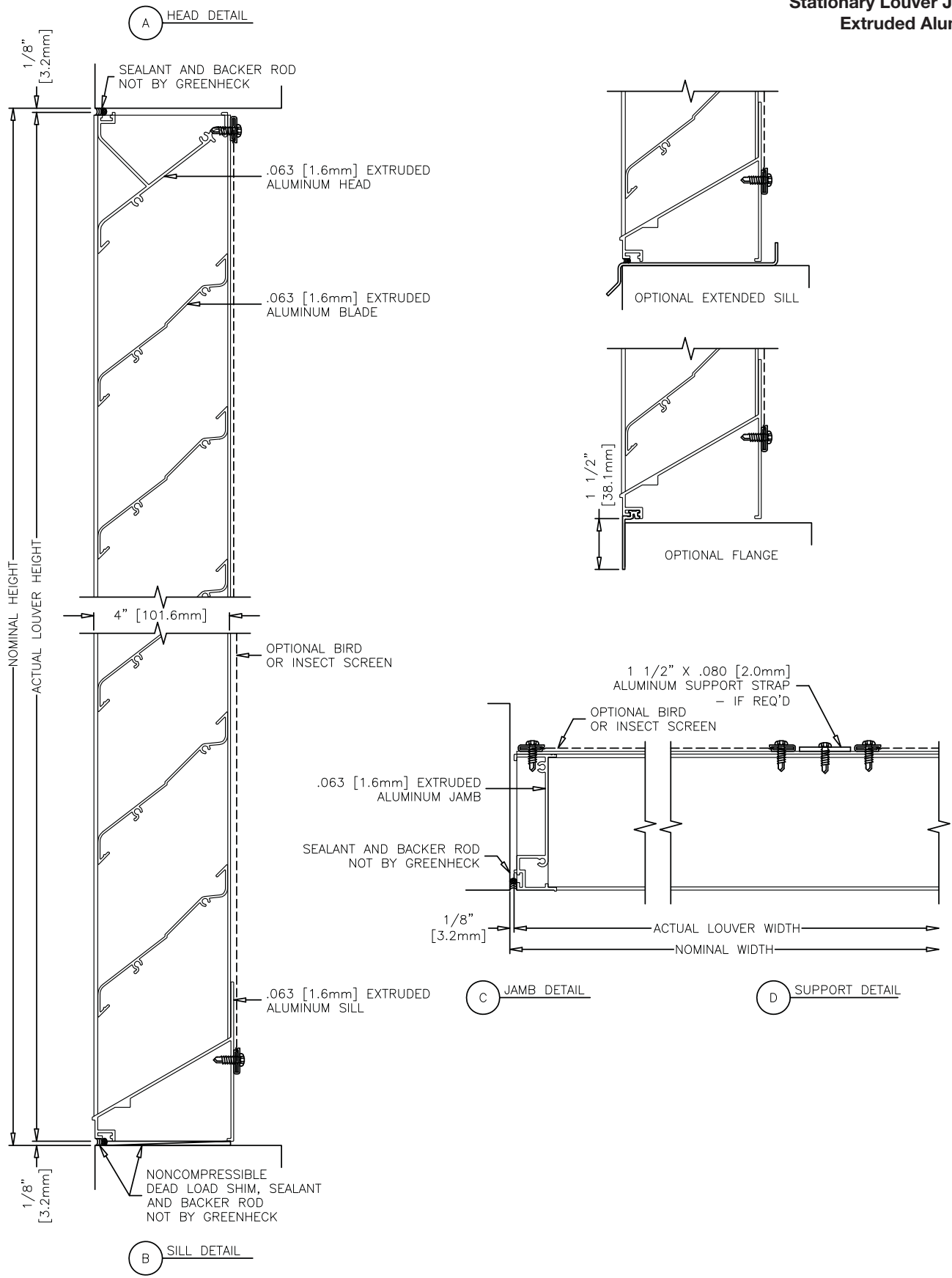

# OPTION DRAWINGS

# ESJ-401LT

Stationary Louver J Blade  
Extruded Aluminum

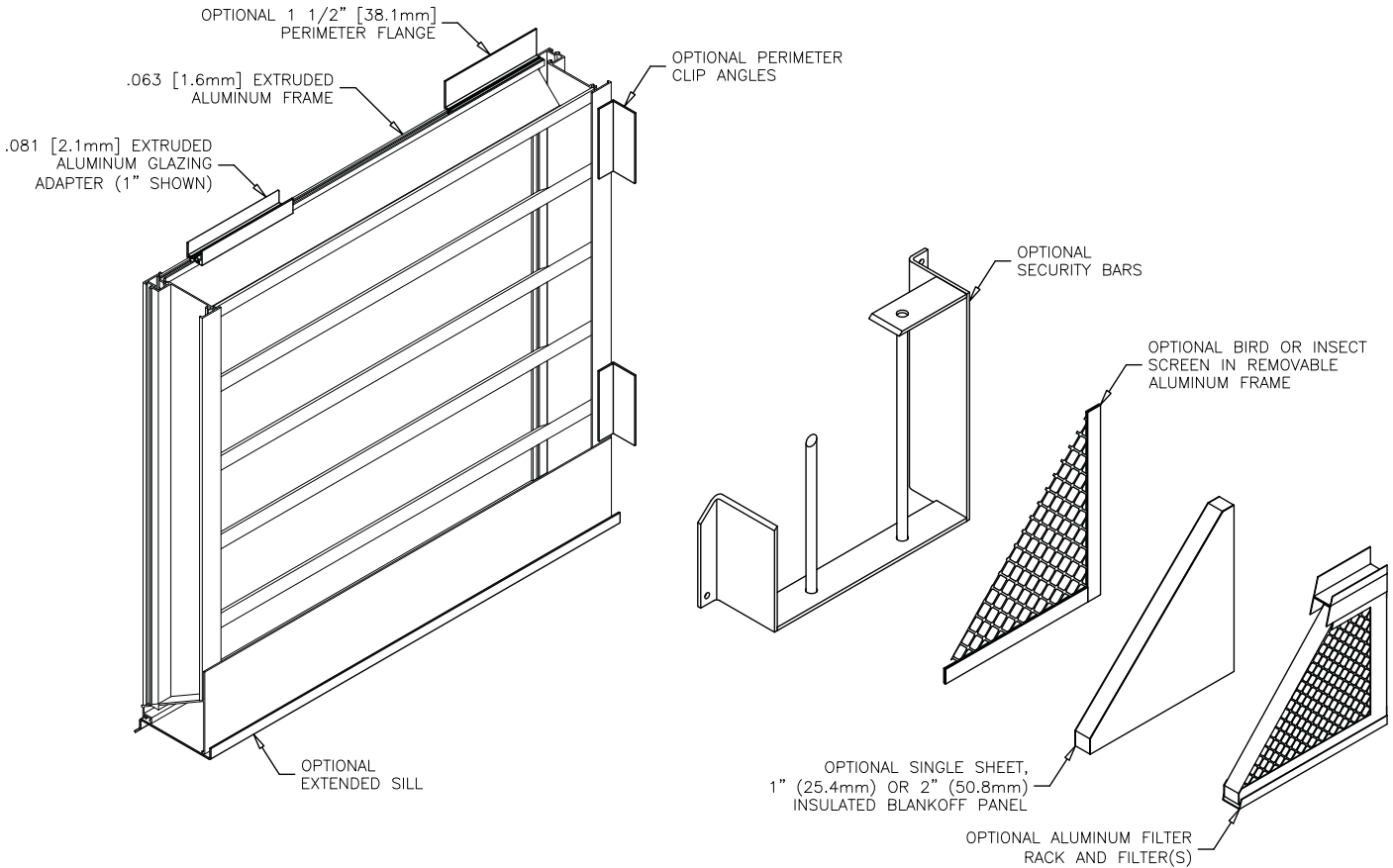

## FINISHES

Finish Type	Description/Application	Color Selection	Standard Warranty (Aluminum)
2-coat 70% KYNAR 5000®/HYLAR 5000® AAMA 2605 – Dry film thickness 1.2 mil. (AKA: Duranar®, Fluoropon®, Trinar®, Fluoropolymer, Polyvinylidene Fluoride, PVDF2)	<b>“Best.”</b> The premier finish for extruded aluminum. Tough, long-lasting coating has superior color retention and abrasive properties. Resists chalking, fading, chemical abrasion and weathering.	<b>Standard Colors:</b> Any of the 24 standard colors shown can be furnished in 70% or 50% KYNAR 5000®/HYLAR 5000® or Baked Enamel.  <b>2-Coat Mica:</b> Greenheck offers 9 standard 2-coat Mica colors. Other colors are available. Consult Greenheck for possible extra cost when selecting non-standard colors or special finishes.	10 Years (Consult Greenheck for availability of extended warranty)
2-coat 50% KYNAR 5000®/HYLAR 5000® AAMA 2604 – Dry film thickness 1.2 mil. (AKA: Acroflur®, Acrynar®)	<b>“Better.”</b> Tough, long-lasting coating has excellent color retention and abrasive properties. Resists chalking, fading, chemical abrasion and weathering.		5 Years
Baked Enamel AAMA 2603 – Dry film thickness 0.8 mil. (AKA: Acrabond Plus®, Duracron®)	<b>“Good.”</b> Provides good adhesion and resistance to weathering, corrosion and chemical stain.		1 Year
Integral Color Anodize AA-M10C22A42 (>0.7 mil)	“Two-step” anodizing is produced by following the normal anodizing step with a second, colorfast process.	Light, Medium or Dark Bronze; Champagne; Black	5 years
Clear Anodize 215 R-1 AA-M10C22A41 (>0.7 mil)	Clear, colorless and hard oxide aluminum coating that resists weathering and chemical attack.	Clear	5 years
Clear Anodize 204 R-1 AA-M10C22A31 (0.4-0.7 mil)	Clear, colorless and hard oxide aluminum coating that resists weathering and chemical attack.	Clear	1 Year
Industrial coatings	Greenheck offers a number of industrial coatings such as Hi-Pro Polyester, Epoxy, and Permatector®. Consult a Greenheck Product Specialist for complete color and application information.		Consult Greenheck
Mill	Materials may be supplied in natural aluminum or galvanized steel finish when normal weathering is acceptable and there is no concern for color or color change.		n/a

Finishes meet or exceed AAMA 2605, AAMA 2604, and AAMA 2603 requirements. Please consult [www.greenheck.com](http://www.greenheck.com) for complete information on standard and extended paint warranties. Paint finish warranties are not applicable to steel products.

