

Stationary Louver Drainable Blade

Application and Design

ESD-635 is a weather louver designed to protect air intake and exhaust openings in building exterior walls. Design incorporates drain gutters in the head member and horizontal blades to channel water to the jambs where water is further channeled through vertical downspouts and out at the sloped sill. The ESD-635 is an **AMCA CERTIFIED LOUVER** enabling designers to select and apply with confidence.

Standard Construction

- Frame** Heavy gauge extruded 6063-T5 aluminum, 6 in. x 0.081 in. nominal wall thickness
- Blades** Drainable design, heavy gauge extruded 6063-T5 aluminum, 0.081 in. nominal wall thickness, positioned at 37° angles on approximately 4 in. centers
- Construction** . . . Mechanically fastened
- Birdscreen** 3/4 in. x 0.051 in. flattened expanded aluminum in removable frame, inside mount (rear)
- Finish** Mill
- Minimum Size** . . 12 in. W x 12 in. H
- Maximum Single Section Size** . . . 120 in. W or 120 in. H (limited to 70 ft. sq.)

Options (at additional cost)

- A variety of bird and insect screens
- Clip angles
- Blank off panel
- Extended sill
- Filter rack
- Flanged frame
- Glazing adaptor
- Hinged frame
- Security bars
- Welded construction
- 0.125 nominal wall thickness
- A variety of architectural finishes including:
 - Clear anodize
 - Integral color anodize
 - Baked enamel paint
 - Kynar paint

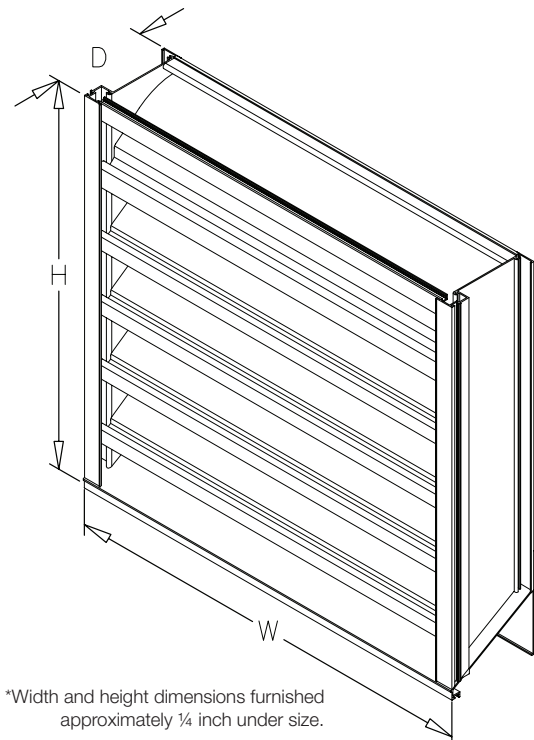
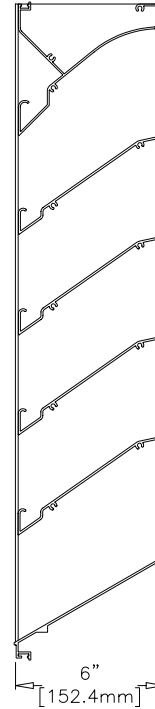

*Width and height dimensions furnished approximately 1/4 inch under size.

PERFORMANCE DATA

ESD-635

Stationary Louver Drainable Blade
Extruded Aluminum

Free Area Chart (Sq. ft.)

| Louver Height Inches | Louver Width in Inches | | | | | | | | | | | | | | | | | | |
|----------------------|------------------------|------|-------|-------|-------|-------|-------|-------|-------|-------|-------|-------|-------|-------|-------|-------|-------|-------|-------|
| | 12 | 18 | 24 | 30 | 36 | 42 | 48 | 54 | 60 | 66 | 72 | 78 | 84 | 90 | 96 | 102 | 108 | 114 | 120 |
| 12 | 0.19 | 0.32 | 0.44 | 0.57 | 0.69 | 0.82 | 0.94 | 1.04 | 1.16 | 1.29 | 1.41 | 1.54 | 1.66 | 1.79 | 1.91 | 2.01 | 2.13 | 2.26 | 2.38 |
| 18 | 0.48 | 0.80 | 1.11 | 1.42 | 1.74 | 2.05 | 2.36 | 2.60 | 2.91 | 3.22 | 3.54 | 3.85 | 4.16 | 4.48 | 4.79 | 5.02 | 5.34 | 5.65 | 5.96 |
| 24 | 0.77 | 1.27 | 1.77 | 2.27 | 2.77 | 3.27 | 3.76 | 4.14 | 4.64 | 5.14 | 5.64 | 6.14 | 6.63 | 7.13 | 7.63 | 8.01 | 8.51 | 9.01 | 9.50 |
| 30 | 1.05 | 1.73 | 2.41 | 3.09 | 3.77 | 4.45 | 5.13 | 5.64 | 6.32 | 7.01 | 7.69 | 8.37 | 9.05 | 9.73 | 10.41 | 10.92 | 11.60 | 12.28 | 12.96 |
| 36 | 1.35 | 2.22 | 3.09 | 3.97 | 4.84 | 5.71 | 6.59 | 7.24 | 8.11 | 8.99 | 9.86 | 10.73 | 11.61 | 12.48 | 13.35 | 14.01 | 14.88 | 15.76 | 16.63 |
| 42 | 1.62 | 2.67 | 3.71 | 4.76 | 5.81 | 6.86 | 7.91 | 8.69 | 9.74 | 10.79 | 11.84 | 12.89 | 13.94 | 14.99 | 16.03 | 16.82 | 17.87 | 18.92 | 19.97 |
| 48 | 1.92 | 3.17 | 4.42 | 5.67 | 6.91 | 8.16 | 9.41 | 10.34 | 11.59 | 12.84 | 14.09 | 15.33 | 16.58 | 17.83 | 19.08 | 20.01 | 21.26 | 22.51 | 23.75 |
| 54 | 2.18 | 3.60 | 5.02 | 6.44 | 7.85 | 9.27 | 10.69 | 11.75 | 13.17 | 14.58 | 16.00 | 17.42 | 18.83 | 20.25 | 21.67 | 22.73 | 24.15 | 25.56 | 26.98 |
| 60 | 2.49 | 4.10 | 5.71 | 7.32 | 8.94 | 10.55 | 12.16 | 13.37 | 14.98 | 16.59 | 18.21 | 19.82 | 21.43 | 23.04 | 24.66 | 25.87 | 27.48 | 29.09 | 30.70 |
| 66 | 2.75 | 4.53 | 6.32 | 8.10 | 9.88 | 11.67 | 13.45 | 14.79 | 16.57 | 18.36 | 20.14 | 21.92 | 23.71 | 25.49 | 27.27 | 28.61 | 30.40 | 32.18 | 33.96 |
| 72 | 3.05 | 5.03 | 7.01 | 8.99 | 10.97 | 12.95 | 14.93 | 16.41 | 18.39 | 20.37 | 22.35 | 24.33 | 26.31 | 28.29 | 30.27 | 31.75 | 33.73 | 35.71 | 37.69 |
| 78 | 3.31 | 5.46 | 7.61 | 9.76 | 11.91 | 14.06 | 16.21 | 17.83 | 19.98 | 22.13 | 24.28 | 26.43 | 28.58 | 30.73 | 32.88 | 34.49 | 36.64 | 38.79 | 40.94 |
| 84 | 3.62 | 5.96 | 8.31 | 10.66 | 13.00 | 15.35 | 17.69 | 19.45 | 21.80 | 24.15 | 26.49 | 28.84 | 31.19 | 33.53 | 35.88 | 37.64 | 39.98 | 42.33 | 44.68 |
| 90 | 3.88 | 6.40 | 8.91 | 11.43 | 13.95 | 16.46 | 18.98 | 20.87 | 23.38 | 25.90 | 28.42 | 30.93 | 33.45 | 35.96 | 38.48 | 40.37 | 42.88 | 45.40 | 47.92 |
| 96 | 4.18 | 6.90 | 9.61 | 12.32 | 15.04 | 17.75 | 20.46 | 22.50 | 25.21 | 27.92 | 30.64 | 33.35 | 36.06 | 38.78 | 41.49 | 43.52 | 46.24 | 48.95 | 51.66 |
| 102 | 4.44 | 7.33 | 10.21 | 13.09 | 15.98 | 18.86 | 21.74 | 23.90 | 26.79 | 29.67 | 32.55 | 35.44 | 38.32 | 41.20 | 44.09 | 46.25 | 49.13 | 52.01 | 54.90 |
| 108 | 4.75 | 7.83 | 10.91 | 13.99 | 17.07 | 20.15 | 23.23 | 25.54 | 28.62 | 31.70 | 34.78 | 37.66 | 40.94 | 44.02 | 47.10 | 49.41 | 52.49 | 55.57 | 58.65 |
| 114 | 5.01 | 8.26 | 11.51 | 14.76 | 18.01 | 21.26 | 24.51 | 26.95 | 30.20 | 33.45 | 36.70 | 39.95 | 43.20 | 46.45 | 49.70 | 52.14 | 55.39 | 59.64 | 61.89 |
| 120 | 5.31 | 8.76 | 12.21 | 15.66 | 19.10 | 22.55 | 26.00 | 28.58 | 32.03 | 35.48 | 38.92 | 42.37 | 45.82 | 49.27 | 52.71 | 55.30 | 58.74 | 62.19 | 65.64 |



Greenheck Fan Corporation certifies that the ESD-635 louvers shown herein are licensed to bear the AMCA Seal. The ratings shown are based on tests and procedures performed in accordance with AMCA Publication 511 and comply with the requirements of the AMCA Certified Ratings Program. The AMCA Certified Ratings Seal applies to air performance and water penetration ratings.

Airflow Resistance (Standard Air - .075 lb/ft³)

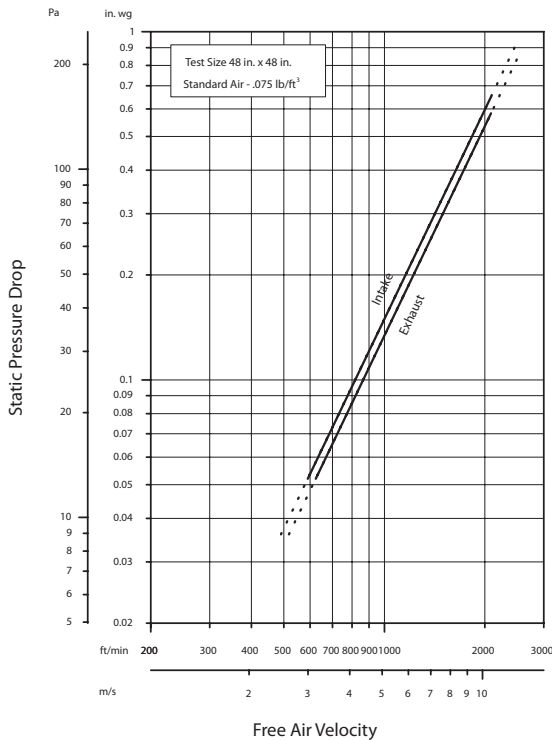

Model ESD-635 resistance to airflow (pressure drop) varies depending on louver application (air intake or air exhaust). Free area velocities (shown) are higher than average velocity through the overall louver size. See louver selection information.

Water Penetration (Standard Air - .075 lb/ft³)

Test size 48 in. x 48 in. Test duration of 15 min.

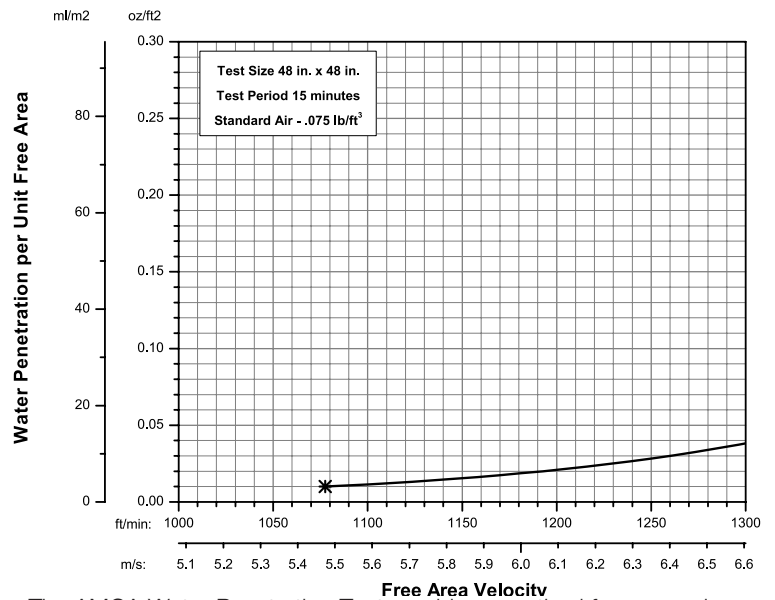

The AMCA Water Penetration Test provides a method for comparing various louver models and designs as to their efficiency in resisting the penetration of rainfall under specific laboratory test conditions. The beginning point of water penetration is defined as that velocity where the water penetration curve projects through .01 oz. of water (penetration) per sq. ft. of louver free area. ***The beginning point of water penetration for Model ESD-635 is 1077 fpm free area velocity.** These performance ratings do not guarantee a louver to be weather-proof or stormproof and should be used in combination with other factors including good engineering judgement in selecting louvers.



INSTALLATION DETAILS

ESD-635

Maximum Size and Installation Information

Stationary Louver Drainable Blade
Extruded Aluminum

Maximum single section size for model ESD-635 is 120 in. W x 84 in. H or 84 in. W x 120 in. H (70 sq. ft). Larger openings require field assembly of multiple louver panels to make up the overall opening size. Individual louver panels are designed to withstand a 25 PSF wind-load (please consult Greenheck if the louvers must withstand higher wind-loads). Structural reinforcing members may be required to adequately support and install multiple louver panels within a large opening. Structural reinforcing members along with any associated installation hardware is not provided by Greenheck unless indicated otherwise by Greenheck. Additional information on louver installation may be found in AMCA Publication #501, Louver Application Manual.

SINGLE SECTION
W/ SUPPORT ANGLES

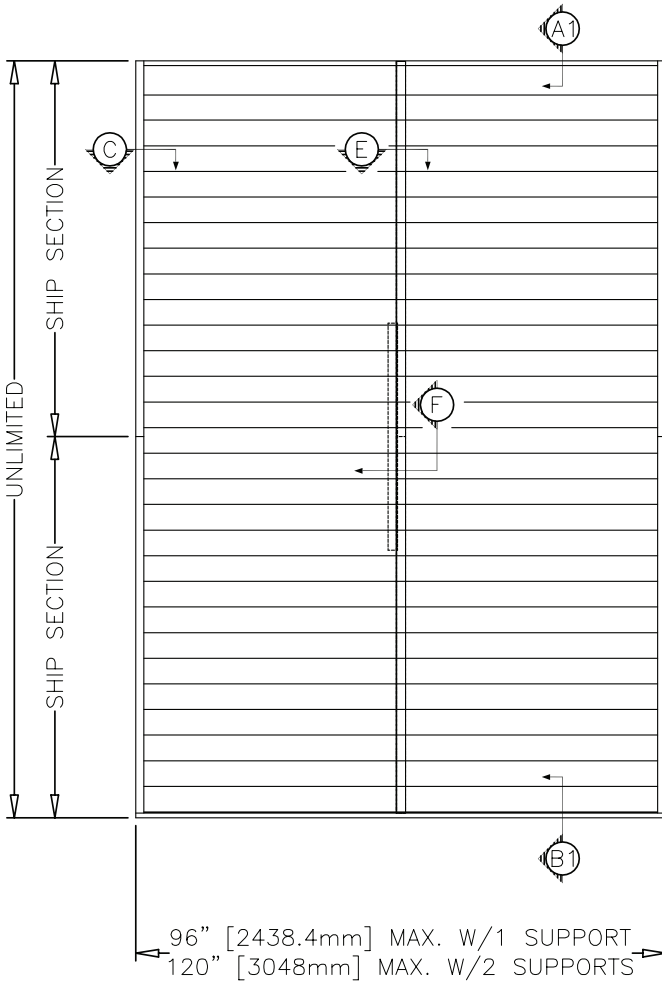

MULTIPLE SECTION W/ MULLION

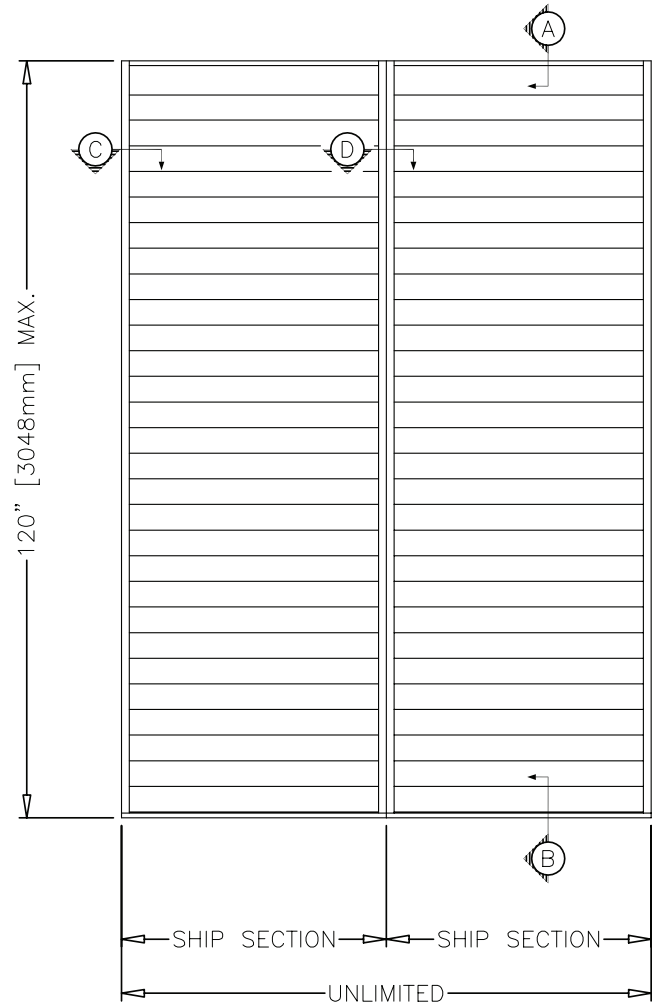

Minimum Single Section Size
12 in. W x 12 in. H

Maximum Single Section Size
70 sq. ft.

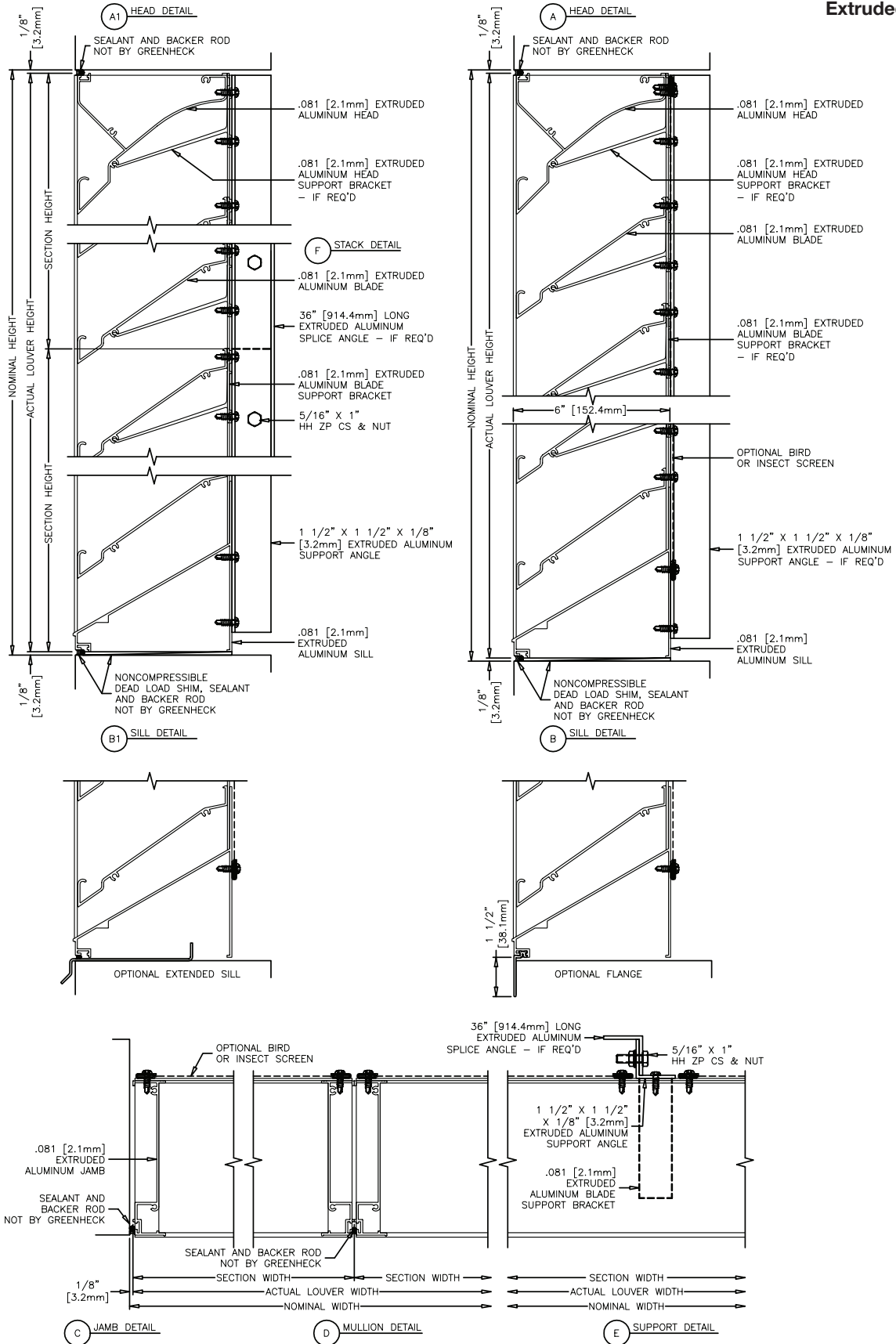

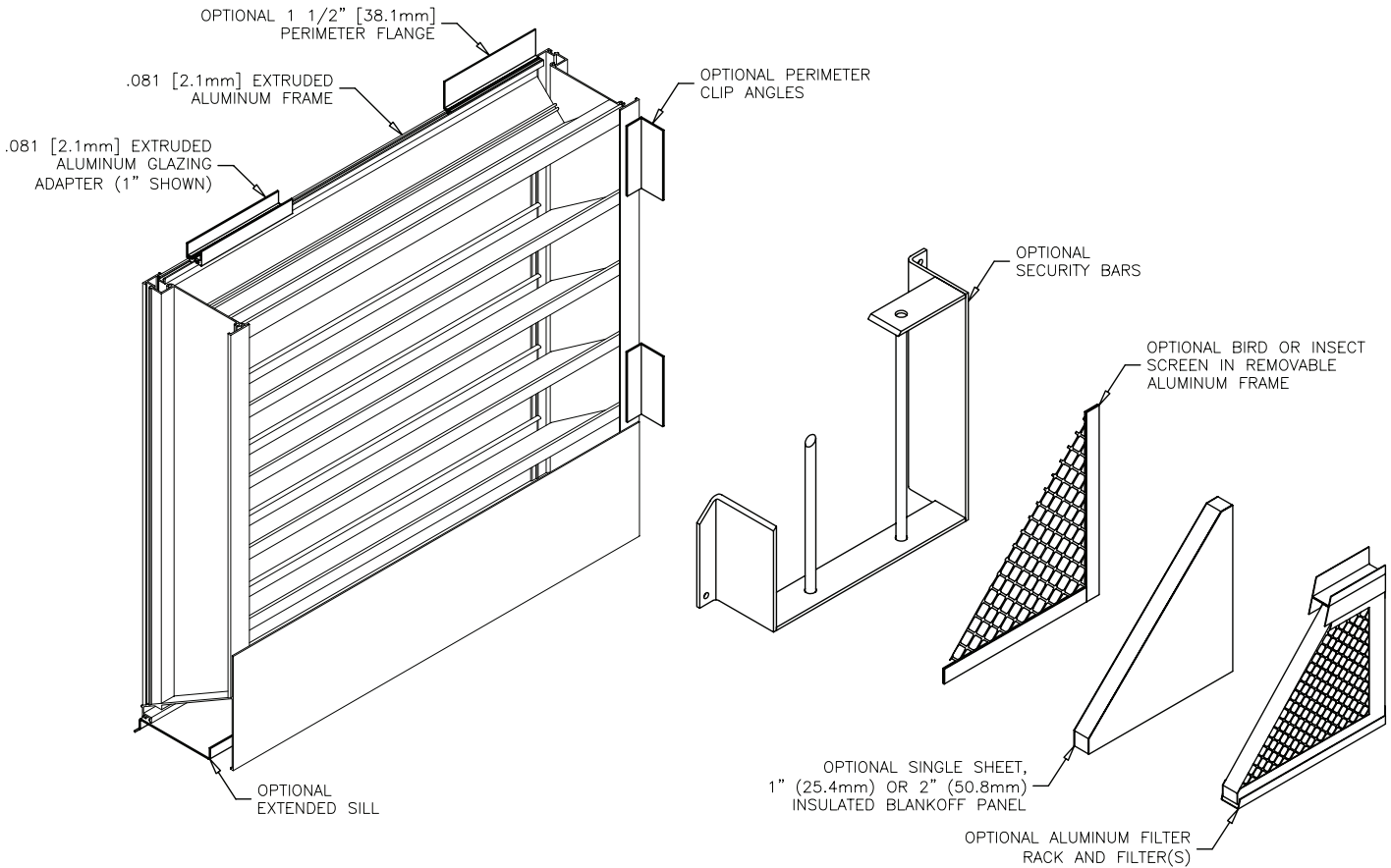

FINISHES

| Finish Type | Description/Application | Color Selection | Standard Warranty (Aluminum) |
|--|--|--|---|
| 2-coat 70% KYNAR 5000®/HYLAR 5000® AAMA 2605 – Dry film thickness 1.2 mil. (AKA: Duranar®, Fluoropon®, Trinar®, Fluoropolymer, Polyvinylidene Fluoride, PVDF2) | “Best.” The premier finish for extruded aluminum. Tough, long-lasting coating has superior color retention and abrasive properties. Resists chalking, fading, chemical abrasion and weathering. | Standard Colors: Any of the 24 standard colors shown can be furnished in 70% or 50% KYNAR 5000®/HYLAR 5000® or Baked Enamel. 2-Coat Mica: Greenheck offers 9 standard 2-coat Mica colors. Other colors are available. Consult Greenheck for possible extra cost when selecting non-standard colors or special finishes. | 10 Years (Consult Greenheck for availability of extended warranty) |
| 2-coat 50% KYNAR 5000®/HYLAR 5000® AAMA 2604 – Dry film thickness 1.2 mil. (AKA: Acroflur®, Acrynar®) | “Better.” Tough, long-lasting coating has excellent color retention and abrasive properties. Resists chalking, fading, chemical abrasion and weathering. | | 5 Years |
| Baked Enamel AAMA 2603 – Dry film thickness 0.8 mil. (AKA: Acrabond Plus®, Duracron®) | “Good.” Provides good adhesion and resistance to weathering, corrosion and chemical stain. | | 1 Year |
| Integral Color Anodize AA-M10C22A42 (>0.7 mil) | “Two-step” anodizing is produced by following the normal anodizing step with a second, colorfast process. | Light, Medium or Dark Bronze; Champagne; Black | 5 years |
| Clear Anodize 215 R-1 AA-M10C22A41 (>0.7 mil) | Clear, colorless and hard oxide aluminum coating that resists weathering and chemical attack. | Clear | 5 years |
| Clear Anodize 204 R-1 AA-M10C22A31 (0.4-0.7 mil) | Clear, colorless and hard oxide aluminum coating that resists weathering and chemical attack. | Clear | 1 Year |
| Industrial coatings | Greenheck offers a number of industrial coatings such as Hi-Pro Polyester, Epoxy, and Permatector®. Consult a Greenheck Product Specialist for complete color and application information. | | Consult Greenheck |
| Mill | Materials may be supplied in natural aluminum or galvanized steel finish when normal weathering is acceptable and there is no concern for color or color change. | | n/a |

Finishes meet or exceed AAMA 2605, AAMA 2604, and AAMA 2603 requirements. Please consult www.greenheck.com for complete information on standard and extended paint warranties. Paint finish warranties are not applicable to steel products.

