

**EM-40 SERIES**
**Horizontal Mount - Vertical Airflow Down**
**Application and Design**

The EM-40 series is a horizontally mounted backdraft damper that is designed to allow vertical airflow down and prevent reverse airflow. The damper is opened by air pressure differential and closed by gravity. Standard models include adjustable counterbalance weights to assist closing.

**Ratings** (See page 2 for specific limitations)

**Pressure:** 4.0 - 10.0 in. wg (996 Pa - 2491 Pa)  
differential pressure

**Velocity:** 2500 to 3500 fpm (13m/s - 18 m/s)

**Temperature:** 180°F (82°C)

	Standard
<b>Frame Material</b>	6063T5 Extruded Aluminum
<b>Frame Thickness</b>	.125 in. (3.2mm)
<b>Blade Material</b>	6063T5 Extruded Aluminum
<b>Blade Thickness</b>	.070 in. (1.8mm)
<b>Axle</b>	3/4 in. (19mm) metallic
<b>Axle Linkage</b>	1/8 in. (3mm) plated steel
<b>Bearings</b>	Synthetic (acetal) sleeve type
<b>Blade Seals</b>	Vinyl

W x H	Minimum Size	Maximum Single Section Size
Inches	8 x 11	48 x 74
mm	203 x 279	1219 x 1880

Sizes larger than maximum shown will be supplied as two or more equal size smaller dampers required to make up the size specified. These larger multiple damper assemblies require field assembly and may require additional reinforcement (not supplied by Greenheck) to support the assembly.

**Options and Accessories**

- 1½ in. flange on discharge: EM-41
- 1½ in. flange on intake: EM-42
- APC (Adjustable Pressure Controller). Allows field setting of relief pressure on all EM dampers. Use one per panel. Maximum recommended pressure set limitations are as follows:

Area ft <sup>2</sup> (m <sup>2</sup> )	Maximum Set Pressure in. wg (Pa)
4 (.37)	.75 (187)
6 (.56)	.50 (125)
8 (100)	.40 (100)
10 (.93)	.30 (75)
15 (1.39)	.20 (50)
20 (1.86)	.15 (37)
24 (2.23)	.125 (31)

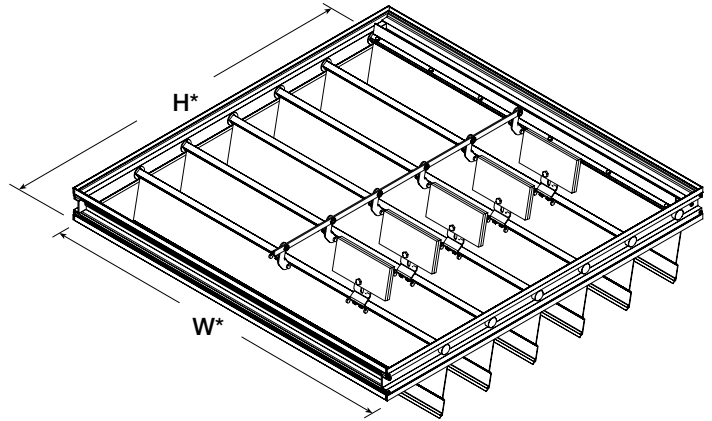

\*W & H dimensions furnished approximately ¼ in. (6mm) under size.

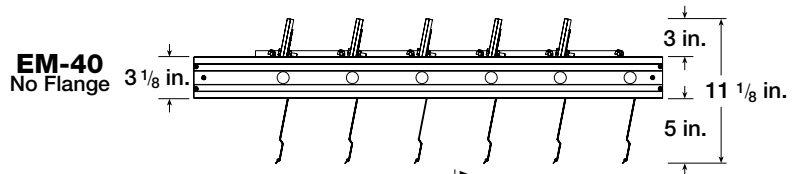

**EM-41**  
Flange On Discharge

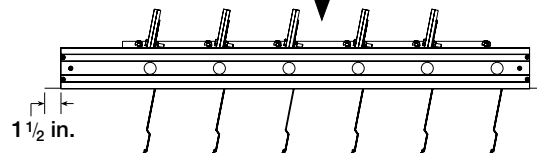

**EM-42**  
Flange On Intake

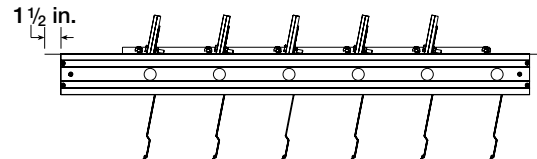

Performance data results from testing a 36 in. x 36 in. (914mm x 914mm) damper in accordance with AMCA Standard 500-D using Figure 5.7A (unducted). All data has been corrected to represent standard air at 0.075 lb/ft<sup>3</sup> (1.201 kg/m<sup>3</sup>).

Operational Data		ÆP in. wg (Pa)	Velocity fpm (m/s)
Damper with Standard Bearings	Blades Start to Open	0.07 (17)	50 (.254)
	Blades Fully Open	0.20 (50)	1200 (6.2)

Leakage testing was conducted in accordance with AMCA Standard 500-D and is expressed as CFM per sq. ft. of damper face area. All data has been corrected to represent standard air at 0.075 lb/ft<sup>3</sup> (1.201 kg/m<sup>3</sup>).

**Leakage**  
36 in. x 36 in. Damper

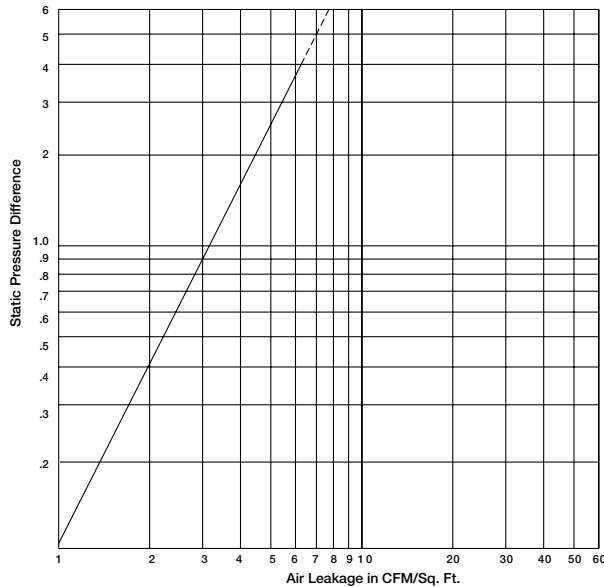

## Specifications

Backdraft dampers meeting the following specifications shall be furnished and installed where shown on plans and/or as described in schedules. Dampers shall consist of: heavy gauge 6063T5 extruded aluminum channel frame (0.125 in.[3.2mm] thick) with 3 1/8 in. (79mm) depth; blades from 0.070 in.(1.8mm) 6063T5 extruded aluminum; 3/4 in. (19mm) dia. metallic axles turning in acetal bearings; damper shall be equipped with extruded vinyl blade seals; and internal 1/8 in. (3mm) plated steel blade-to-blade linkage. Damper manufacturer's printed application and performance data including pressure, velocity and temperature limitations shall be submitted for approval showing damper suitable for pressures to 10 in. wg (2491 Pa), velocities to 3500 fpm (18 m/s) and temperatures to 180°F (82°C). Testing and ratings to be in accordance with AMCA Standard 500-D.

Basis of design is Greenheck model EM-40.



## Pressure Drop

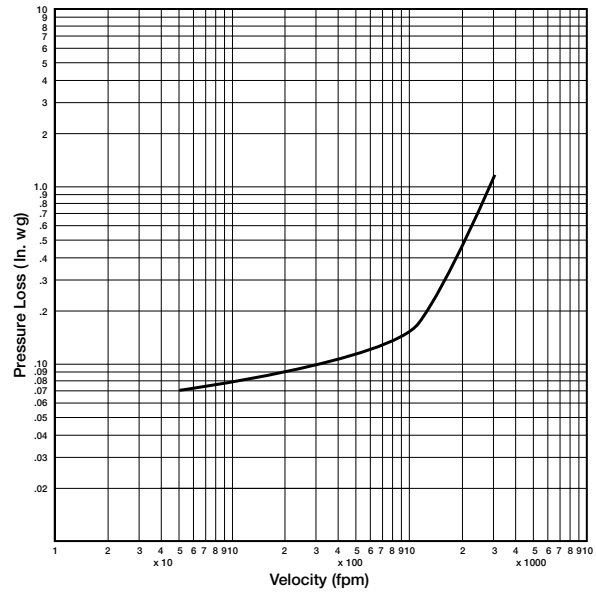

## Pressure Limitations

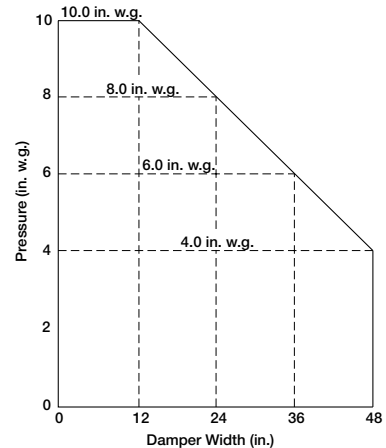

## Velocity Limitations

