

Installation, Operation and Maintenance Manual

Please read and save these instructions for future reference. Read carefully before attempting to assemble, install, operate or maintain the product described. Protect yourself and others by observing all safety information. Failure to comply with instructions could result in personal injury and/or property damage!



Differential Pressure Controller Features:

- NEMA-4 and IP56 enclosure rating
- Factory calibrated
- 24 Vdc or 24 Vac input voltage
- Pressure ranges:
 - 0-8.30 inches W.C.
 - 0-22.14 inches W.C.
 - 0-41.52 inches W.C.
 - 0-83.04 inches W.C.
 - 0-138.40 inches W.C.
- Selectable isolated output transmitter linear to differential pressure
 - 4-20 mA
 - 2-10 Vdc
- LCD display with user-friendly touch panel interface
- Temperature compensation
- Remote duct temperature sensor
- Programmable elevation
- English or metric readings
- Simple installation

General Information

This instruction manual provides installation, operating, maintenance, and parts information for Sure-Aire™ Series Differential Pressure Controllers.

WARNING

Improper installation, adjustment, alterations, service or maintenance can cause injury and property damage, as well as possible voiding of factory warranty. No person may install, operate, or maintain the Sure-Aire Differential Pressure Controller(s) and transmitters without first being fully trained and qualified in the installation, operation and maintenance, and carefully reading and understanding the contents of this manual. If you have any questions about these instructions, contact your local representative.

CAUTION

Risk of electrical shock! More than one disconnect switch may be required to de-energize the equipment before servicing.

Table of Contents

General Information	1
Differential Pressure Controller Features.	1
Installation	2
Dimensions and Hole Mounting Patterns	2
Wiring and System Components	2
Label and Order Information	2
Sure-Aire Controller Part Number	2
Display Setting Options and Setup	3-4
4-20 mA Transmitter Calibration Procedure	5
2-10 Vdc Transmitter Calibration Procedure.	6
Temperature Sensor	7
Specifications	7
Maintenance Log.	Backcover
Our Commitment.	Backcover

Installation

WARNING

When wiring the instrument, you must follow industry standard practices for control and protection against electrostatic discharge (ESD). Failure to exercise good ESD practices may cause damage to the controller.

1. Mount the controller in the vertical plane using four #8-32 screws. Open the front cover by unscrewing the two captive thumb screws to gain access to the four mounting locations pictured at right.
2. Use 1/4-inch nylon tubing to connect the corresponding high and low, 1/4-inch quick connect, pressure ports of the Sure-Aire controller to the high and low pressure ports of the termination plate on the fan.
3. Remove terminal block TB1 and perform wiring for the pins listed below. For liquid tight applications, use only 1/2-inch liquid tight conduit.

Terminal Block TB1: Input Power

- Pin 1 = 24V, AC or DC (+ or -)
- Pin 2 = 24V, AC or DC (+ or -)
- Pin 3 = Earth Ground

4. Provide power to the controller to turn it on.
5. Select the desired Output Signal of the controller for the Building Automation System. Use the touch screen to select the 4-20 mA or 2-10 Vdc output signal via the controller's setup menu. (Refer to Display Setting Options and Setup section, Output Signal, pages 3 and 4).

Terminal Block TB2: Transmitter/Temperature Sensor

- Pin 1 = 4-20 mA or 2-10 Vdc (+) (output)
- Note: 4 to 20 mA requires a load resistor 200-900 ohms
- Pin 2 = 4-20 mA or 2-10 Vdc (-) (output)
- Pin 3 = Shield
- Pin 4 = Remote Temperature Sensor (input)
- Pin 5 = Remote Temperature Sensor (input)

Note: Signal isolator may be required when two or more output signals share a common connection at the PLC/controller.

7. If temperature compensation is desired, mount the provided temperature sensor in contact with the airstream. Wire the temperature sensor into TB2 and change Temperature Comp to "Yes" via the controller's setup menu.
8. When the above steps are completed, make sure the front cover is properly aligned to the housing and the two captive thumb screws are securely tightened.

Dimensions and Hole Mounting Pattern

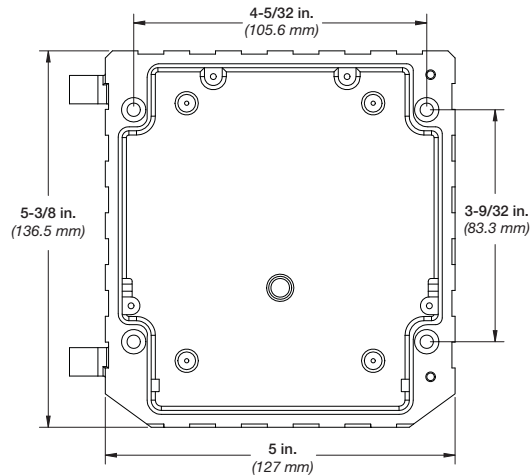

Wiring and System Components

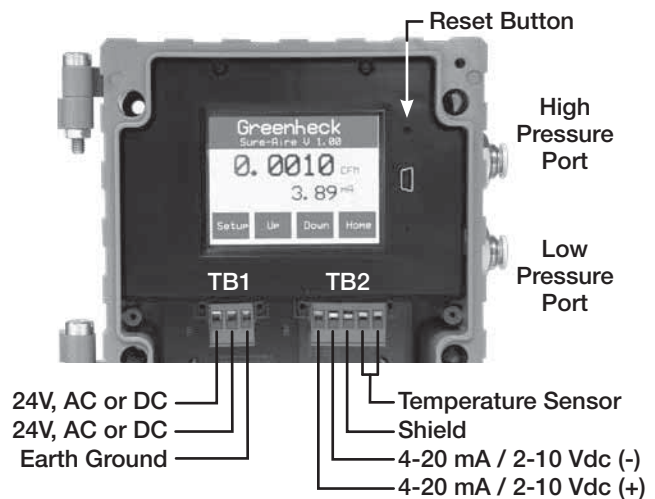

Label and Order Information

The label providing details pertaining to the purchase order is located on the inside cover of the controller.

Equipment for Measurement		TB1 ① 24 Volts AC or DC ② 6VA Max Input Power ③ Earth Ground
	Description: CNTRL,SURE-AIRE,0-22.14" Fan Model: QEP Fan Size: 36 K Factor: 1967 Elevation: 1100 P/N: 384987 Sales Order: 6606573 Tag Mark: SF-1	
		P.O.#0843 Date Code: 8/12 Schofield, WI 54476 U.S.A.

Part Number	Description
384986	CNTRL,SURE-AIRE,0-8.3
384987	CNTRL,SURE-AIRE, 0-22.14
384988	CNTRL,SURE-AIRE, 0-41.52
384989	CNTRL,SURE-AIRE, 0-83.04
384990	CNTRL,SURE-AIRE, 0-138.40

Display Setting Options and Setup

Menu Options: Current settings are displayed in the main display area of the screen. To review current settings, press Up or Down to scroll through the various controller settings as outlined below. Press Home to return to the main screen.

- Elevation
- X-Mitter (output signal)
- Software Version
- K-Factor
- Sensor Installed
- Differential Pressure Measurement
- Sure-Air Controller Temperature
- Flow Temperature
- Flow Rate Measurement
- Air Density

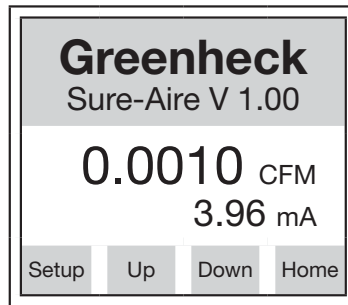

Sure-Aire Controller
LCD Touch Display

The following display setting options can be changed in the Setup menu of the controller:

Measurement System:

Press Edit to change. Press Prev or Next to adjust, then press Enter to store the value.

- English (default)
- Metric

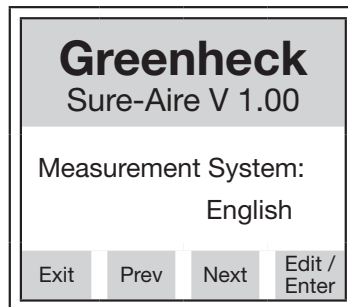

K Factor: Press Edit to change K Factor. Press Inc or Dec to adjust, then press Enter to store the value.

- 200 to 30,000

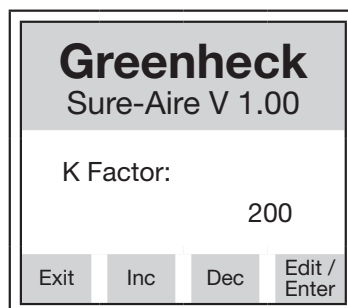

Pressure Units: Press Edit to change pressure units. Press Prev or Next to adjust, then press Enter to store the value.

- In WC (default)
- Ft WC
- mm WC
- cm WC
- PSI
- In Hg
- mm Hg
- mBar
- PA
- KPA - kilopascals (1kPa = 1000 Pa)
- HPA - hectopascals (1 hPa = 100 Pa)
- Oz In.

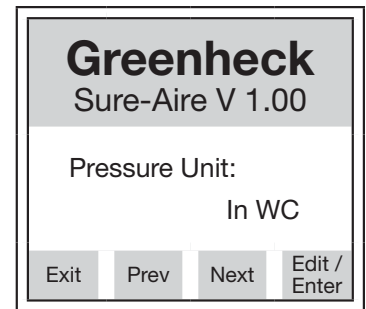

Air Flow Units: Press Edit to change Air Flow Units. Press Prev or Next to adjust, then press Enter to store the value.

- CFM (default)
- m³/hr
- m³/min

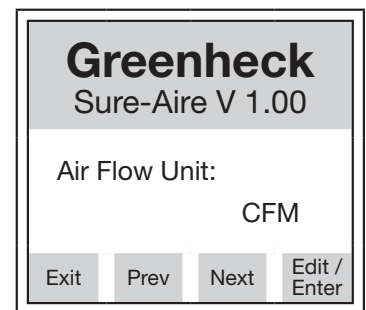

Main Display Value:

Press Edit to change Main Display Value. Press Prev or Next to adjust, then press Enter to store the value.

- Flow (default)
- Pressure
- Temperature
- Air Density
- Output Signal
- None

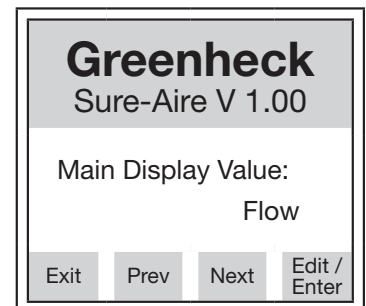

Secondary Display:

Press Edit to change Secondary Display. Press Prev or Next to adjust, then press Enter to store the value.

- Flow
- Pressure
- Temperature
- Air Density
- Output Signal (default)
- None

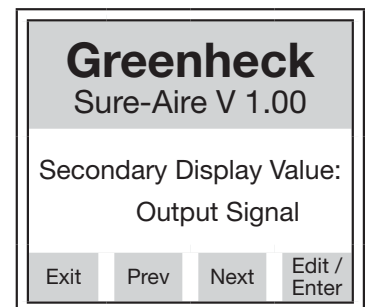

Display Brightness:

Press Edit to change brightness. Press Inc or Dec to adjust, then press Enter to store the value.

- 10 - 100% (80% default)

Greenheck			
Sure-Aire V 1.00			
Display Brightness %:			
80			
Exit	Inc	Dec	Edit / Enter

Transmitter Min Value:

Press Edit to change Transmitter Min Value. Press Inc or Dec to adjust, then press Enter to store the value.

NOTE: See Transmitter Calibration

Greenheck			
Sure-Aire V 1.00			
Transmitter Min Value:			
1827			
Exit	Inc	Dec	Edit / Enter

Elevation: Press Edit to change elevation. Press Inc or Dec to adjust, then press Enter to store the value.

- 0 - 10,000 ft (0 ft default)

Greenheck			
Sure-Aire V 1.00			
Elevation:			
800ft			
Exit	Inc	Dec	Edit / Enter

Transmitter Max Value:

Press Edit to change Transmitter Max Value. Press Inc or Dec to adjust, then press Enter to store the value.

NOTE: See Transmitter Calibration

Greenheck			
Sure-Aire V 1.00			
Transmitter Max Value:			
720			
Exit	Inc	Dec	Edit / Enter

Temperature Compensation:

Press Edit to change Temperature Compensation. Press Prev or Next to adjust, then press Enter to store the value.

- Yes (default)
- No

Greenheck			
Sure-Aire V 1.00			
Temperature Comp:			
Yes			
Exit	Prev	Next	Edit / Enter

Note: If temperature compensation is set to 'No', the air density will be a function of standard temperature (70°F/21°C).

Output Signal: Press Edit to change Output Signal type. Press Prev or Next to adjust, then press Enter to store the value.

- 4-20 mA (default)
- 2-10 Vdc

Note: Output signal is linear to differential pressure. The equation provided on the Sure-Aire label adhered to the fan must be used to calculate volume.

Greenheck			
Sure-Aire V 1.00			
Output Signal:			
4-20 mA			
Exit	Prev	Next	Edit / Enter

WARNING

Due to load resistance change from product to product, it may be necessary to recalibrate the 4-20 mA transmitter. See 4-20 mA calibration procedure.

4-20 mA Transmitter Calibration Procedure

WARNING

Due to load resistance change from product to product, it may be necessary to recalibrate the 4-20 mA transmitter.

1.0 Test Equipment

- 1.1 Digital Multimeter. Set multimeter to read mA DC
- 1.2 Load resistor. Select a series Load Resistor between 200 and 900 ohms.

2.0 Interconnect Wiring

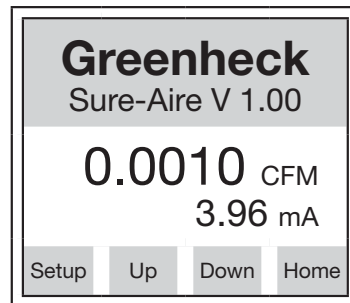
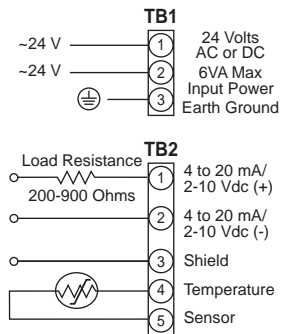

Sure-Aire Controller
LCD Touch Display

- 2.1 Validate the controller is setup for 4-20 mA output signal.
- 2.2 Validate the power is off on the DC power supply and the Sure-Aire controller.
- 2.3 Validate the multimeter is set to read mA DC.
- 2.4 Select a series Load Resistor between 200 and 900 ohms and install one end to TB2-1.
- 2.5 Interconnect the multimeter (+) probe to the other end of the load resistor.
- 2.6 Interconnect the multimeter (-) probe to TB2-2 to complete the current loop.
- 2.7 Apply power to the Sure-Aire controller.
- 2.8 Press the Setup button on the Touch Panel interface.
- 2.9 Keep pressing Next button until you reach the Transmitter Min Value screen.
- 2.10 Press Edit, then Inc or Dec until the digital multimeter reads exactly 4.00 mA.

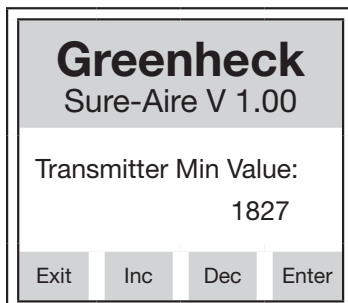

- 2.11 Press Enter to store the new value.
- 2.12 Press Next.

- 2.13 Transmitter Max Value.

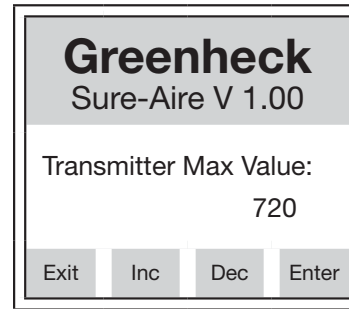

- 2.14 Press Edit, then Inc or Dec until the digital multimeter reads exactly 20.00 mA.
- 2.15 Press Enter to store the new value.
- 2.16 Press Exit to return to the main screen.
- 2.17 4-20 mA transmitter calibration completed.

NOTE

Apply a vacuum to the High Port and the 4-20 mA transmitter will track the span of the pressure range. i.e. The Sure-Aire controller with a pressure sensor of 0 - 41.51 in. W.C. installed, 4.00 mA = 0 in. W.C., 20.00 mA = 41.52 in. W.C.

2-10 Vdc Output Signal Transmitter Calibration Procedure

1.0 Test Equipment

- 1.1 Digital multimeter. Set multimeter to read DC voltage.
- 1.2 Make sure Output Signal type is set to 2-10 Vdc.

2.0 Interconnect Wiring

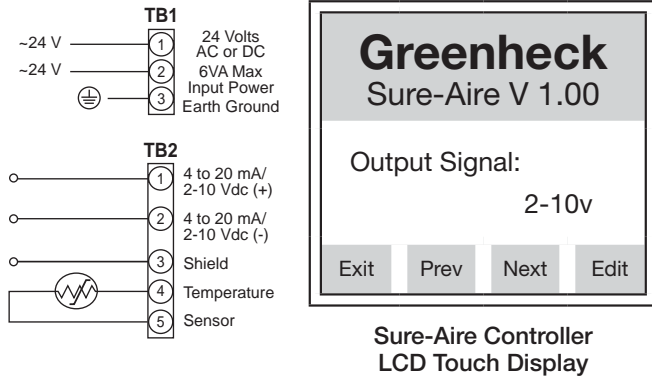

NOTE

Apply a vacuum to the High Port and the 2-10 Vdc transmitter will track the span of the pressure range. i.e. The Sure-Aire controller with a pressure sensor of 0 - 41.51 in. W.C. installed, 2.00 Vdc = 0 in. W.C., 10.00 Vdc = 41.52 in. W.C.

- 2.1 Validate the power is off on the DC power supply and the Sure-Aire controller.
- 2.2 Validate the multimeter is set to read DC voltage.
- 2.3 Interconnect the multimeter (+) probe to TB2 pin 1.
- 2.4 Interconnect the multimeter (-) probe to TB2 pin 2.
- 2.5 Apply power to the Sure-Aire controller.
- 2.6 Press the Setup button on the Touch Panel Interface.
- 2.7 Keep pressing the Next button until you reach the Transmitter Min Value screen.
- 2.8 Press Edit, then Inc or Dec until the digital multimeter reads exactly 2.00 Vdc

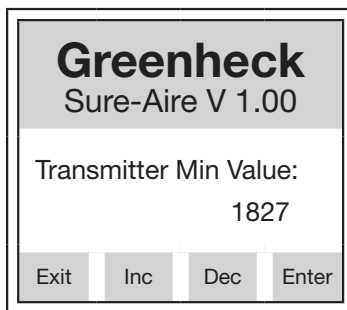

- 2.9 Press Enter to store the new value.
- 2.10 Press Next.
- 2.11 Transmitter Max Value.

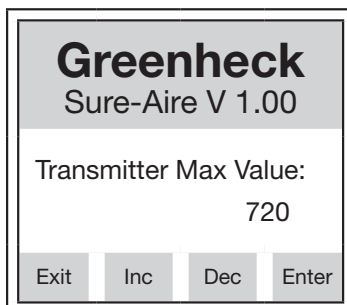

Temperature Sensor

Interconnect the remote temperature sensor by connecting the temperature sensor to pins 4 and 5 of TB2. The Remote Temperature Sensor will adjust the air density value in the controller based on the sensor measurement when Temperature Compensation is set to 'Yes'. This density compensation will affect the flow rate accordingly. If Temperature Compensation is set to 'No', the air density value will be a function of standard air (70°F/21°C).

Specifications

- Service:** Air and non-combustible, compatible gases
- Enclosure Rating:** NEMA-4 and IP56
- Dimensions:** 5 x 5-3/8 x 2-1/2 inches (127 x 136.5 x 63.5 mm)
- Mounting:** Mount unit in vertical plane with #8-32 screws (4 hole locations)
- Accuracy:** $\pm 0.5\%$ full pressure scale at 77°F (25°C)
- Thermal Effects:** 0.015% / °F (0.027% / °C) from -13° thru 185°F (25° thru 85°C)
- Stability:** < $\pm 1\%$ per year
- Max. Pressure Limit:** 72 psi (1993 inches W.C.)
- Temperature Limits:** 32° to 140°F (0 to 60°C)
- Power Requirements:** 24 Vdc or 24 Vac input voltage
- Power Consumption:** Power = 6VA
- Output Signal:** User selectable. 4-20 mA (900 ohms max.) or 2-10 Vdc
- Connections:** Euro-type removable terminal blocks with 1/2 inch watertight conduit fittings.
- Pressure Connections:** 1/4 inch quick connect
- Weight:** 1.5 lbs.
- Agency Approvals:** ETL #3192905

Maintenance Log

Date _____ Time _____ AM/PM

Notes: _____

Date _____ Time _____ AM/PM

Notes: _____

Date _____ Time _____ AM/PM

Notes: _____

Date _____ Time _____ AM/PM

Notes: _____

Date _____ Time _____ AM/PM

Notes: _____

Date _____ Time _____ AM/PM

Notes: _____

Date _____ Time _____ AM/PM

Notes: _____

Date _____ Time _____ AM/PM

Notes: _____

Our Commitment

As a result of our commitment to continuous improvement, Greenheck reserves the right to change specifications without notice.

Specific Greenheck product warranties are located on greenheck.com within the product area tabs and in the Library under Warranties.

Greenheck's Sure-Aire™ Flow Monitoring System catalog provides additional information describing the equipment, fan performance, available accessories, and specification data.

AMCA Publication 410-96, Safety Practices for Users and Installers of Industrial and Commercial Fans, provides additional safety information. This publication can be obtained from AMCA International, Inc. at www.amca.org.

