

Installation, Operation, and Maintenance Instructions

This manual is the property of the owner, and is required for future maintenance.
Please leave it with the owner when the job is complete.

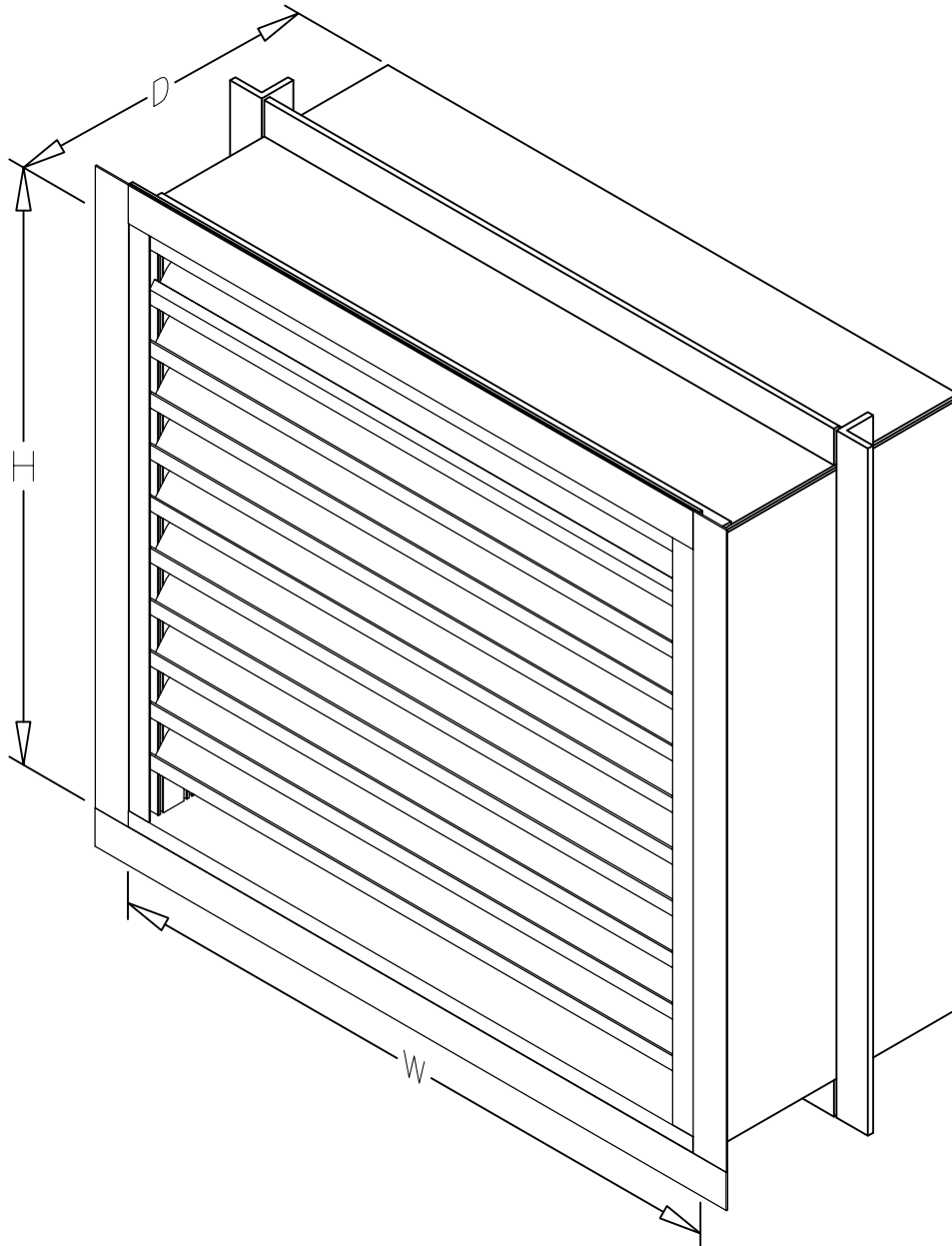

SAFETY WARNING:

Improper installation, adjustment, alteration, service or maintenance can cause property damage, injury or death. Read the installation, operating, and maintenance instructions thoroughly before installing or servicing this equipment.

Maximum Size and Installation Information

Model EHH-601D is a Miami-Dade Qualified and Florida Product Approved louver and must be installed in accordance with the installation instructions shown herein. Model EHH-601D is qualified for installation within concrete/masonry, steel stud, structural steel or wood framed building conditions. Model EHH-601D is structurally calculated to withstand positive and negative wind-loads up to 150 PSF. The maximum single section rough opening width is 72.50 in. The maximum single section rough opening height is 144.50 in. While the maximum rough opening height is limited to 144.50 in., the rough opening width is limited to 1,000 in. as multiple sections may be installed side by side in accordance with installation instructions.

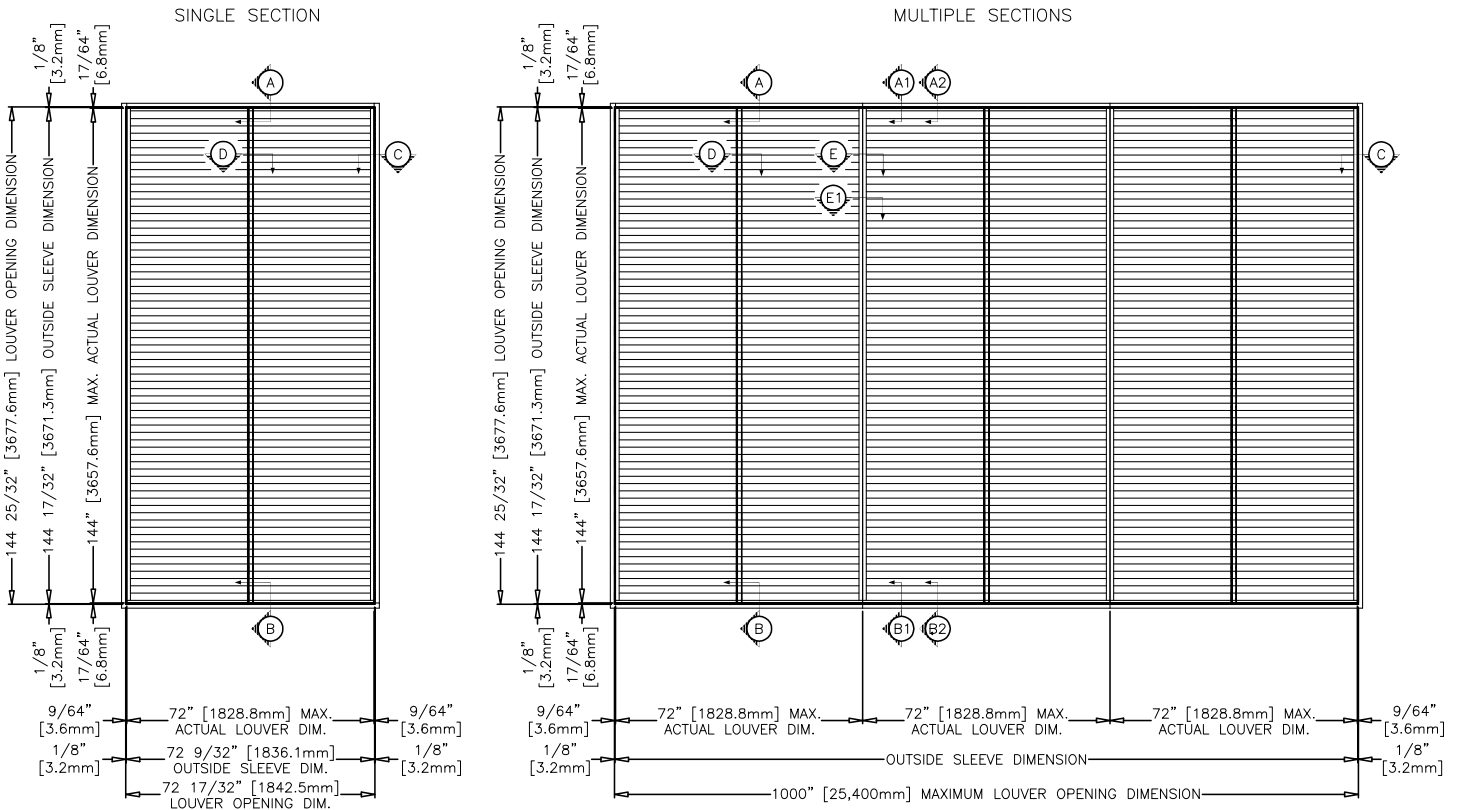

**Minimum Rough
Opening Size**
12 in. W x 7 in. H

**Maximum Single Section
Rough Opening Size**
72.50 in. W x 144.50 in. H

Building Condition/Substrate Limitations

- All wood substrate shall be G= 0.55 density or better
- All metal stud substrate should be min. 16 Ga. FY= 50 KSI
- All structural steel substrate shall be min. 0.25 in. thick FY= 36 KSI
- All concrete substrate shall be min. 3000 PSI
- Concrete masonry shall be ASTM C90, Type II, 2000 PSI, grout-filled

Installation Instructions

EHH-601D

Flange/Sleeve Installation
Single Section

Florida Product Approval No: FL10088
Miami-Dade NOA No.: 10-0921.10
Maximum Wind-load: 150 PSF

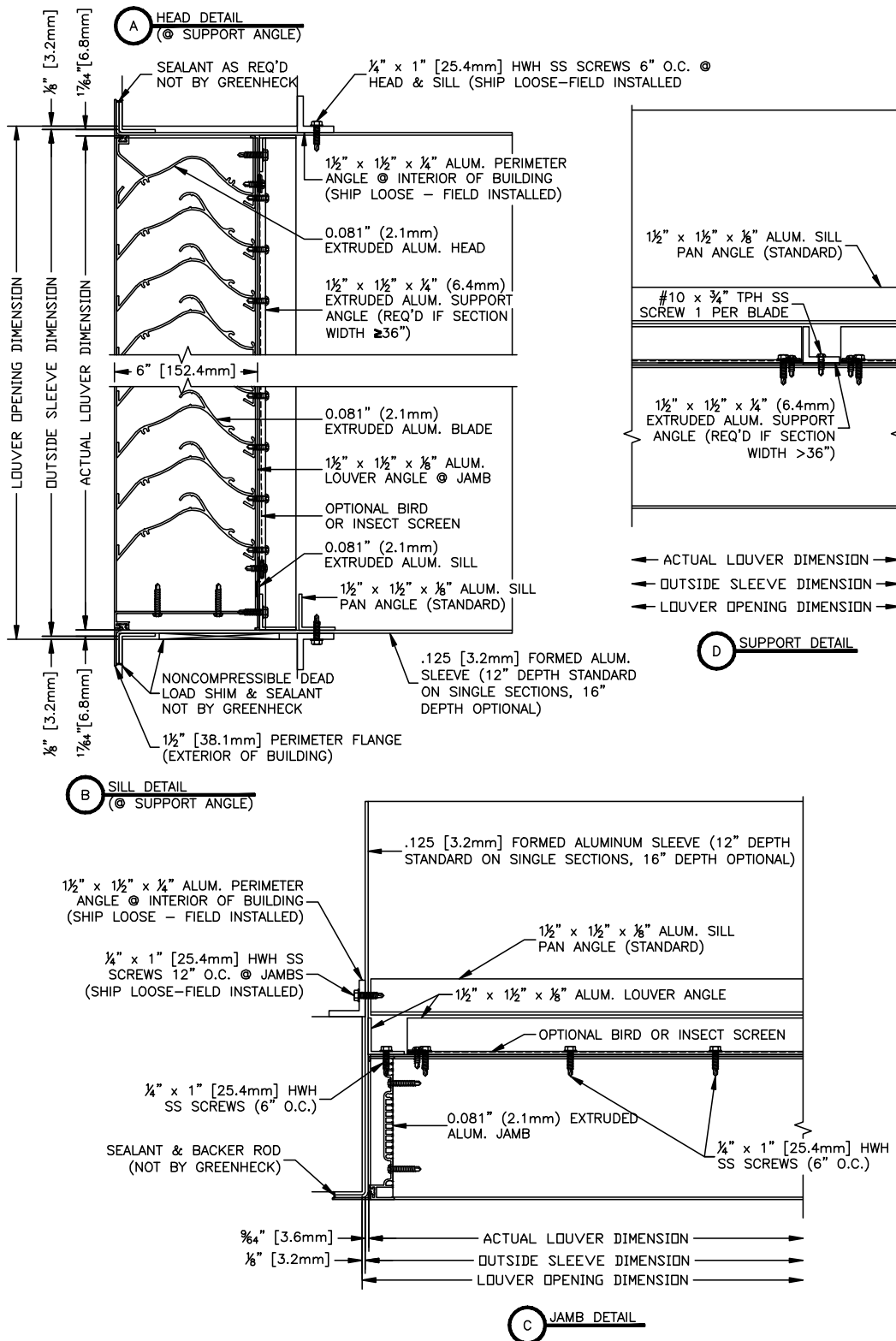

Installation Instructions

EHH-601D

Flange/Sleeve Installation

Florida Product Approval No: FL10088

Multiple Sections

Miami-Dade NOA No.: 10-0921.10

Height $\leq 96 \frac{1}{2}$

Maximum Wind-load: 150 PSF

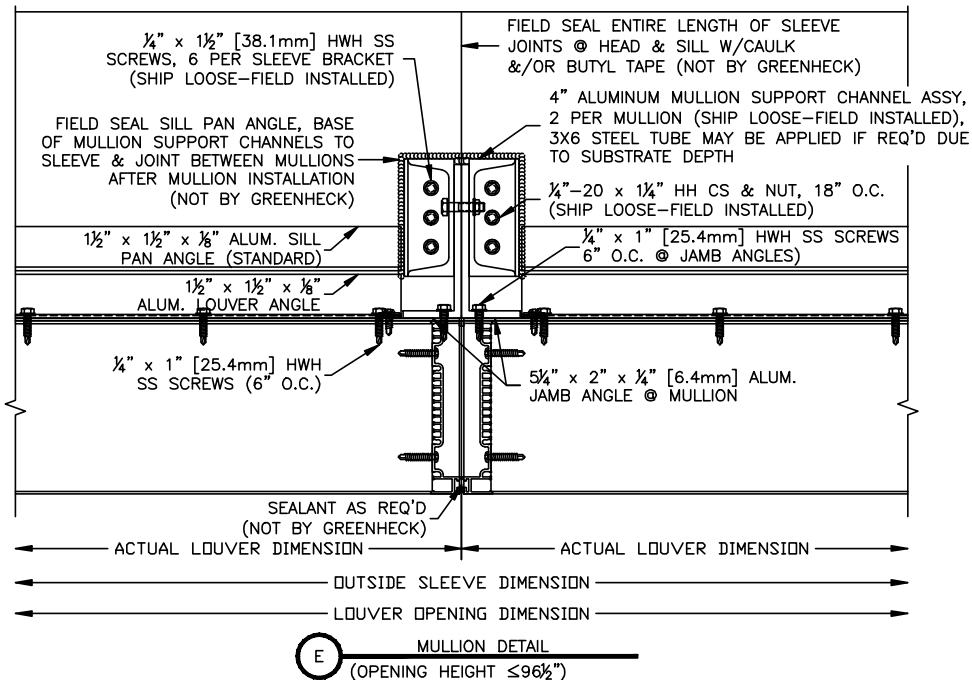
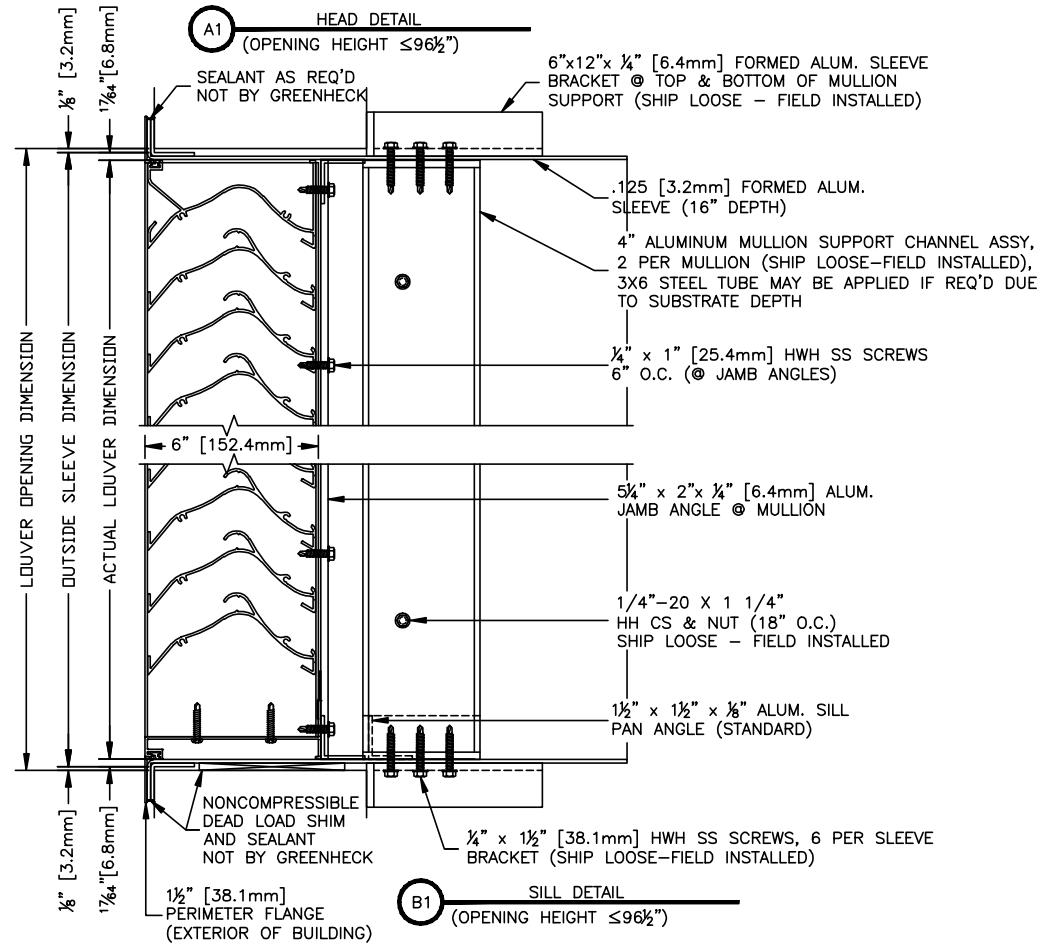

Installation Instructions

EHH-601D

Flange/Sleeve Installation

Florida Product Approval No: FL10088

Multiple Sections

Miami-Dade NOA No.: 10-0921.10

Height > 96 1/2" ≤ 144 1/2"

Maximum Wind-load: 150 PSF

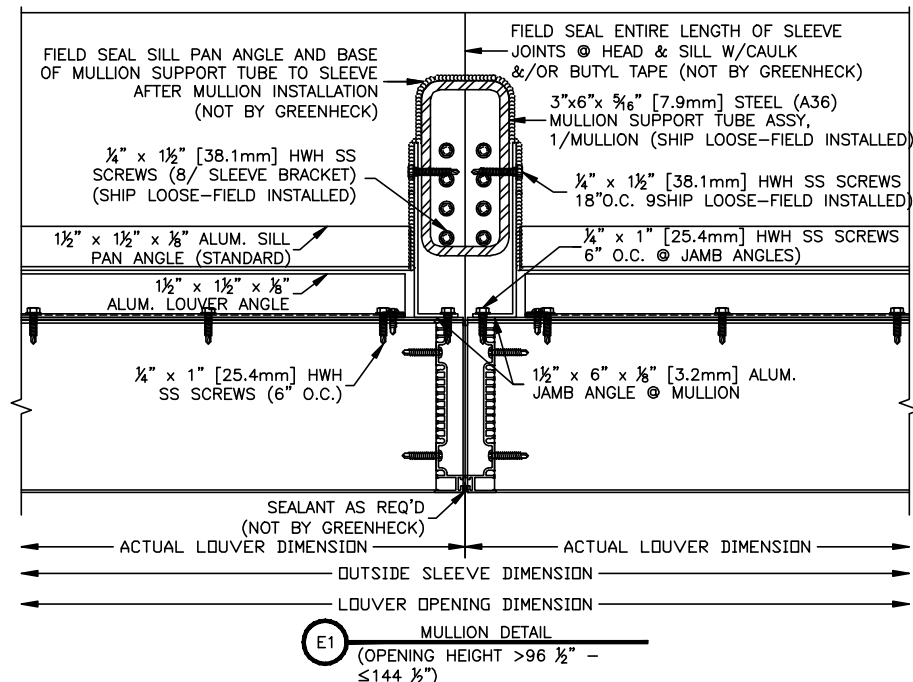
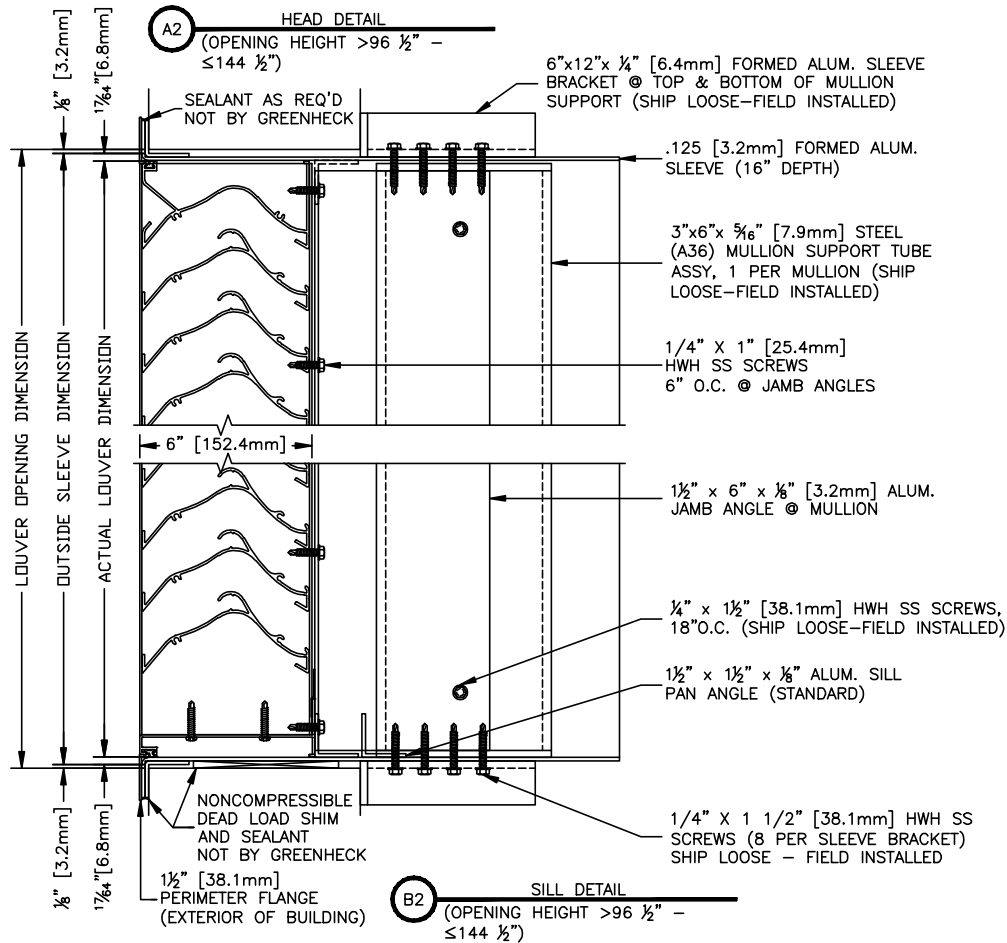

Installation Instructions

EHH-601D

Flange/Sleeve Installation Single Section

Florida Product Approval No: FL10088
Miami-Dade NOA No.: 10-0921.10
Maximum Wind-load: 150 PSF

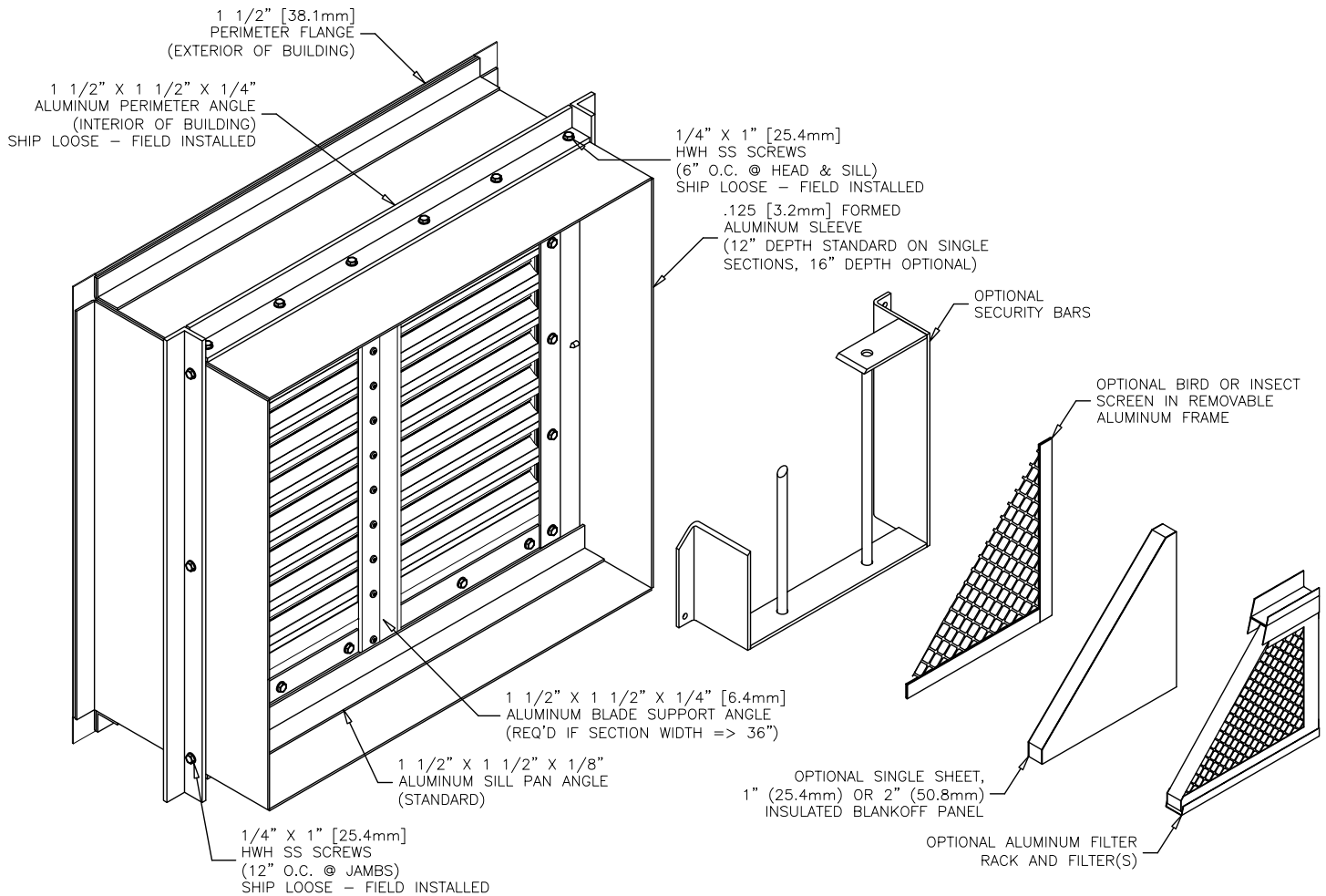

Structure Depth

- Min. structure depth 4 in.
- Max. structure depth 10.5 in. (12 in. sleeve)
- Max. structure depth 14.5 in. (16 in. sleeve)

Installation Instructions

EHH-601D

Flange/Sleeve Installation

Multiple Sections

Height $\leq 96 \frac{1}{2}$

Florida Product Approval No: FL10088

Miami-Dade NOA No.: 10-0921.10

Maximum Wind-load: 150 PSF

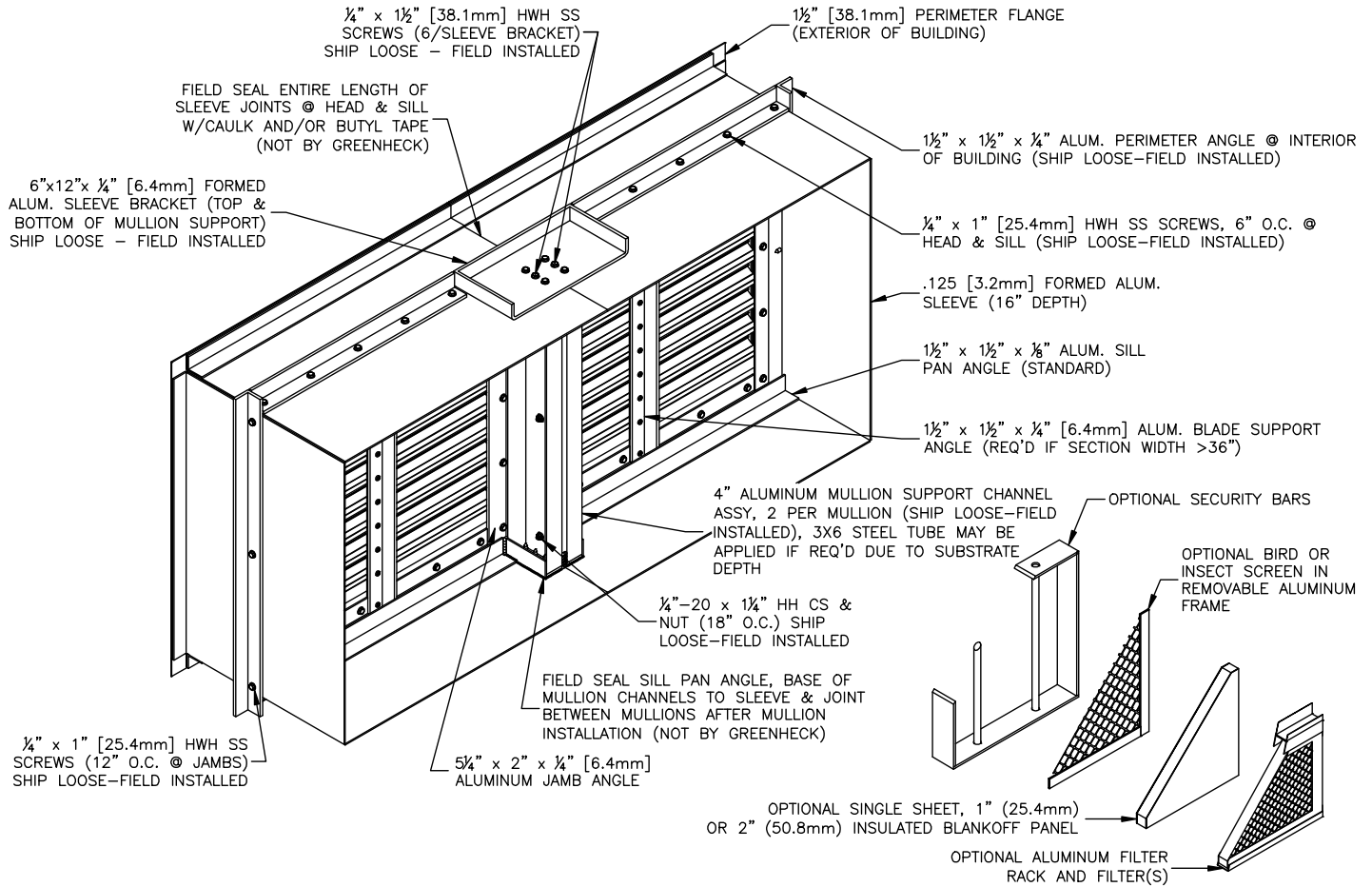

Structure Depth

- Min. structure depth 4 in.
- Max. structure depth 11.5 in.

Installation Instructions

EHH-601D

Flange/Sleeve Installation

Multiple Sections

Height > 96 1/2 ≤ 144 1/2

Florida Product Approval No: FL10088

Miami-Dade NOA No.: 10-0921.10

Maximum Wind-load: 150 PSF

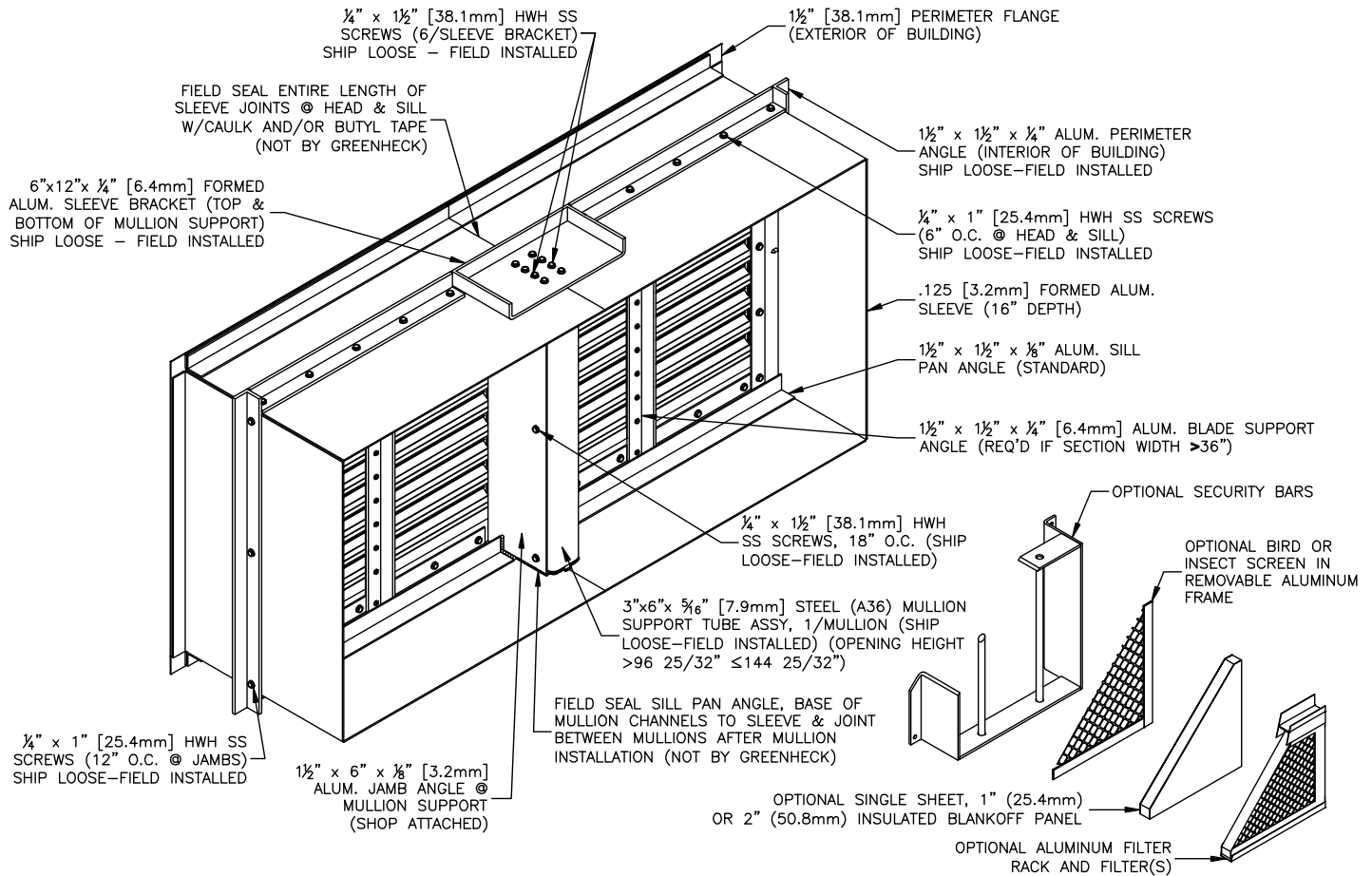

Structure Depth

- Min. structure depth 4 in.
- Max. structure depth 13.25 in.

