

Installation, Operation and Maintenance Manual

Please read and save these instructions. Read carefully before attempting to assemble, install, operate or maintain the product described. Protect yourself and others by observing all safety information. Failure to comply with instructions could result in personal injury and/or property damage! Retain instructions for future reference.

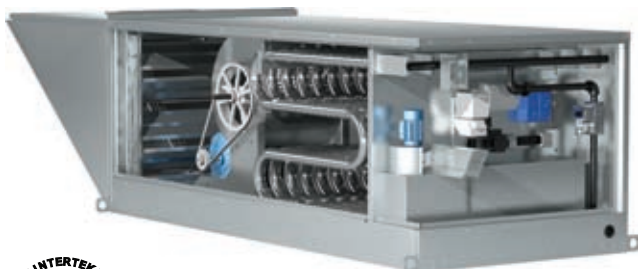

2. The rotation of the wheel is critical. It must be free to rotate without striking or rubbing any stationary objects.
3. Motor must be securely and adequately grounded.
4. Do not spin fan wheel faster than the maximum cataloged fan rpm. Adjustments to fan speed significantly effects motor load. If the fan RPM is changed, the motor current should be checked to make sure it is not exceeding the motor nameplate amps.
5. Do not allow the power cable to kink or come in contact with oil, grease, hot surfaces or chemicals. Replace cord immediately if damaged.
6. Verify that the power source is compatible with the equipment.
7. Never open blower access doors while the fan is running.

General Safety Information

Only qualified personnel should install this unit. Personnel should have a clear understanding of these instructions and should be aware of general safety precautions. Improper installation can result in electric shock, possible injury due to coming in contact with moving parts, as well as other potential hazards. Other considerations may be required if high winds or seismic activity are present. If more information is needed, contact a licensed professional engineer before moving forward.

1. Follow all local electrical and safety codes, as well as the National Electrical Code (NEC), the National Fire Protection Agency (NFPA), where applicable. Follow the Canadian Electric Code (CEC) in Canada.

DANGER

Always disconnect power before working on or near a unit. Lock and tag the disconnect switch or breaker to prevent accidental power up.

CAUTION

When servicing the unit, motor may be hot enough to cause pain or injury. Allow motor to cool before servicing.

FOR YOUR SAFETY

If you smell gas:

1. Open windows.
2. Do not touch electrical switches.
3. Extinguish any open flame.
4. Immediately call your gas supplier.

FOR YOUR SAFETY

The use and storage of gasoline or other flammable vapors and liquids in open containers in the vicinity of this appliance is hazardous.

WARNING

Improper installation, adjustment, alteration, service or maintenance can cause property damage, injury or death. Read the installation, operating and maintenance instructions thoroughly before installing or servicing this equipment.

Receiving

Upon receiving the product check to make sure all items are accounted for by referencing the bill of lading to ensure all items were received. Inspect each crate for shipping damage before accepting delivery. Notify the carrier if any damage is noticed. The carrier will make notification on the delivery receipt acknowledging any damage to the product. All damage should be noted on all the copies of the bill of lading which is countersigned by the delivering carrier. A Carrier Inspection Report should be filled out by the carrier upon arrival and the Traffic Department. If damaged upon arrival, file claim with carrier. Any physical damage to the unit after acceptance is not the responsibility of Greenheck Fan Corporation.

Unpacking

Verify that all required parts and the correct quantity of each item have been received. If any items are missing report shortages to your local representative to arrange for obtaining missing parts. Sometimes it is not possible that all items for the unit be shipped together due to availability of transportation and truck space. Confirmation of shipment(s) must be limited to only items on the bill of lading.

Handling

Units are to be rigged and moved by the lifting brackets provided or by the skid when a forklift is used. Location of brackets varies by model and size. Handle in such a manner as to keep from scratching or chipping the coating. Damaged finish may reduce ability of unit to resist corrosion.

Storage

Units are protected against damage during shipment. If the unit cannot be installed and operated immediately, precautions need to be taken to prevent deterioration of the unit during storage. The user assumes responsibility of the unit and accessories while in storage. The manufacturer will not be responsible for damage during storage. These suggestions are provided solely as a convenience to the user.

1. Plug all piping
2. Store belts flat to keep them from warping and stretching

INDOOR — The ideal environment for the storage of units and accessories is indoors, above grade, in a low humidity atmosphere which is sealed to prevent the entry of blowing dust, rain, or snow. Temperatures should be evenly maintained between 30°F (-1°C) and 110°F (43°C) (wide temperature swings may cause condensation and “sweating” of metal parts). All accessories must be stored indoors in a clean, dry atmosphere.

Remove any accumulations of dirt, water, ice, or snow and wipe dry before moving to indoor storage. To avoid “sweating” of metal parts allow cold parts to reach room temperature. To dry parts and packages

use a portable electric heater to get rid of any moisture build up. Leave coverings loose to permit air circulation and to allow for periodic inspection.

The unit should be stored at least 3½ in. (89 mm) off the floor on wooden blocks covered with moisture proof paper or polyethylene sheathing. Aisles between parts and along all walls should be provided to permit air circulation and space for inspection.

OUTDOOR — Units designed for outdoor applications may be stored outdoors, if absolutely necessary. Roads or aisles for portable cranes and hauling equipment are needed.

The fan should be placed on a level surface to prevent water from leaking into the unit. The unit should be elevated on an adequate number of wooden blocks so that it is above water and snow levels and has enough blocking to prevent it from settling into soft ground. Locate parts far enough apart to permit air circulation, sunlight, and space for periodic inspection. To minimize water accumulation, place all unit parts on blocking supports so that rain water will run off.

Do not cover parts with plastic film or tarps as these cause condensation of moisture from the air passing through heating and cooling cycles.

Inspection and Maintenance during Storage

While in storage, inspect fans once per month. Keep a record of inspection and maintenance performed.

If moisture or dirt accumulations are found on parts, the source should be located and eliminated. At each inspection, rotate the fan wheel by hand ten to fifteen revolutions to distribute lubricant on motor. Every three months, the fan motor should be energized. If paint deterioration begins, consideration should be given to touch-up or repainting. Fans with special coatings may require special techniques for touch-up or repair.

Machined parts coated with rust preventive should be restored to good condition promptly if signs of rust occur. Immediately remove the original rust preventive coating with petroleum solvent and clean with lint-free cloths. Polish any remaining rust from surface with crocus cloth or fine emery paper and oil. Do not destroy the continuity of the surfaces. Wipe thoroughly clean with Tectyl® 506 (Ashland Inc.) or the equivalent. For hard to reach internal surfaces or for occasional use, consider using Tectyl® 511M Rust Preventive or WD-40® or the equivalent.

REMOVING FROM STORAGE — As units are removed from storage to be installed in their final location, they should be protected and maintained in a similar fashion, until the equipment goes into operation.

Prior to installing the unit and system components, inspect the unit assembly to make sure it is in working order.

1. Check all fasteners, set screws on the fan, wheel, bearings, drive, motor base, and accessories for tightness.

2. Rotate the fan wheel(s) by hand and assure no parts are rubbing.
3. After storage period, purge grease before putting fan into service.

Indirect Gas Fired Unit Installations

Units are listed for installation in the United States and Canada

- Installation of gas fired duct furnaces must conform with local building codes. In the absence of local codes, installation must conform to the National Fuel Gas code, ANSI Z223.1 or in Canada, CAN/CGA-B149 installation codes.
- All electrical wiring must be in accordance with the regulation of the National Electric Code, ANSI/NFPA-70.
- Unit is approved for installation downstream from refrigeration units. In these conditions, condensate could form in the duct furnace and provision must be made to dispose of the condensate.

Table of Contents

Installation

Clearance to Combustibles/Service Clearances.	3
Unit Arrangement DB	4
Weatherhood	4
Electrical Wiring	5
Gas Piping	6

Start-Up

Blower	7-8
Furnace – All Units	9
2:1 Staged	9

Operation

Furnace - 2:1 Staged	10
----------------------	----

Troubleshooting

Blower	11
Motor Overamps / Too Much Airflow	12
Excessive Noise or Vibration	13
Insufficient Airflow	14
Furnace – 2:1 Staged	15

Maintenance

Routine	16-17
Fall	17

Reference

Vent Connections	18
Typical Gas Train Layout	18
Control Center Layout	18
Performance Table	18
Control Flow Diagram	19
Wiring Diagrams	20-21
Maintenance Start-Up List	22
Maintenance Log	23
Warranty	Backcover

Clearance to Combustibles / Service Clearances

	Floor	Top	Sides	Flue Outlet
Indirect Fired Units*	0 inches (0 mm)	0 inches (0 mm)	0 inches (0 mm)	42 inches (1067 mm)

Clearance to combustibles is defined as the minimum distance required between the heater and adjacent combustible surfaces to ensure the adjacent surface's temperature does not exceed 90 degrees above the ambient temperature.

*Reference venting guidelines for combustion blower clearances.

Recommended Minimum Service Clearances
42 inches (1067 mm) around the sides and ends of the unit*

Clearances for component removal may be greater than the service clearances listed.

*Unit access side is determined by looking into the intake in the direction of airflow.

Installation of Arrangement DB

1. Install Curb

Position curb on the roof (reference the CAPS submittal for placement of curb in relation to the unit).

Attach curb to roof and flash into place.

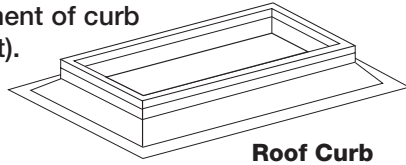

Roof Curb

2. Install Ductwork

Good duct practices should be followed for all ductwork. All ductwork should be installed in accordance with SMACNA and AMCA guidelines, NFPA 96 and all local codes. Reference the CAPS submittal for ductwork sizes.

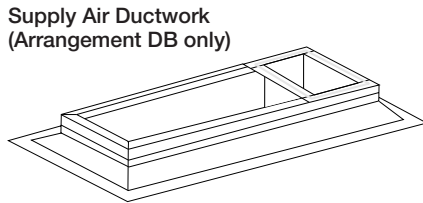

Ductwork

NOTE

The use of a duct adapter is recommended on a downblast (DB) arrangement to align the ductwork with the supply unit. The duct adapter is a guide and is not intended to support for the ductwork.

3. Apply Sealant

Apply an appropriate sealant around the perimeter of the curb and duct adapter(s) to isolate fan vibration and prevent water penetration. Use screws to fasten the unit to the curb/equipment support(s).

NOTE

The use of all lifting lugs and a set of spreader bars is mandatory when lifting the unit.

4. Install Unit

Use a crane and a set of spreader bars hooked to the factory lifting lugs to lift and center the unit on the curb/equipment support(s).

Use self-tapping sheet metal screws to fasten the unit to the curb/equipment support(s).

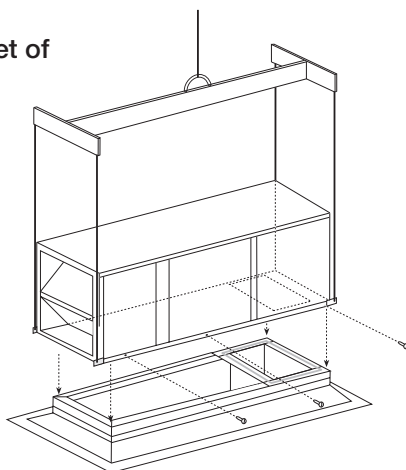

Setting Unit

Installation of Hinged Weatherhood

TOOLS REQUIRED

- 5/16-inch nut runner
- Caulk gun with weatherproof sealant

The IGK weatherhood is folded-up and shipped on top of the unit:

To install:

1. Remove the center filter tracks (2 pieces) attached to the weatherhood.
2. Rotate one side up on weatherhood.
 - a. Run sheet metal screw where shown to hold side in rotated position. Pilot holes are provided.
 - b. Rotate opposite side up on weatherhood and repeat step 2A.
3. Rotate assembly forward.
4. Screw the sides of the weatherhood to the unit. Pilot holes are provided.
5. Caulk all seams with an appropriate weatherproof sealant.
6. Install the two center filter tracks which were shipped inside the unit, attached to the weatherhood.
 - a. Slide the tabbed end of each track into the slot at the bottom of the intake opening on the unit housing.
 - b. Rotate the tracks up to the top outer edge of the weatherhood such that the weatherhood edge slides into the slot in the tracks.

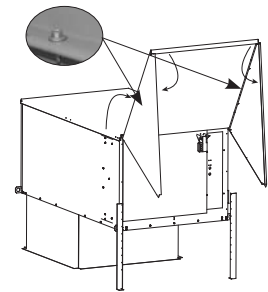
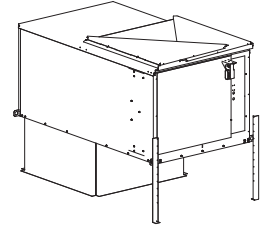

Rotate sides up, install screws. Rotate Assembly forward. Refer to Step 4.

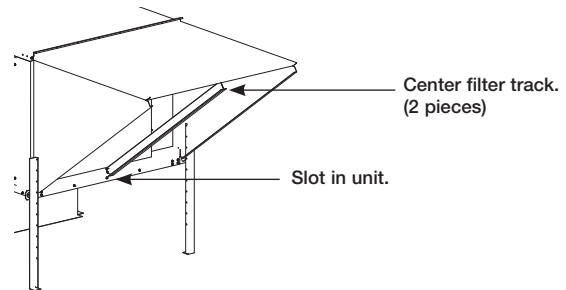

7. Insert the factory provided aluminum mesh intake filter(s) into the track located in the face of the weatherhood. Filters slide in from the top. Be sure the filters are properly orientated (an airflow direction arrow is located on the side of the filters). Insert the retaining screws on the sides of the weatherhood, two (2) per side, to keep the filters in place.

Installation - Electrical Wiring

IMPORTANT

Before connecting power to the unit, read and understand the following instructions and wiring diagrams. Complete wiring diagrams are attached on the inside of the control center door(s).

IMPORTANT

All wiring should be done in accordance with the latest edition of the National Electric Code ANSI/NFPA-70 and any local codes that may apply. In Canada, wiring should be done in accordance with the Canadian Electrical Code.

CAUTION

If replacement wire is required, it must have a temperature rating of at least 105°C, except for energy cut-off or sensor lead wire which must be rated to 150°C.

IMPORTANT

The equipment must be properly grounded. Any wiring running through the unit in the airstream must be protected by metal conduit, metal clad cable or raceways.

DANGER

High voltage electrical input is needed for this equipment. This work should be performed by a qualified electrician.

CAUTION

Any wiring deviations may result in personal injury or property damage. Greenheck is not responsible for any damage to, or failure of the unit caused by incorrect final wiring.

IMPORTANT

Greenheck's standard control voltage is 24 VAC. Control wire resistance should not exceed 0.75 ohms (approximately 285 feet total length for 14 gauge wire; 455 feet total length for 12 gauge wire). If the resistance exceeds 0.75 ohms an industrial-style, plug-in relay should be wired in place of the remote switch. The relay must be rated for at least 5 amps and have a 24 VAC coil. Failure to comply with these guidelines may cause motor starters to chatter or not pull in, resulting in contactor failures and/or motor failures.

1. Determine the Size of the Main Power Lines

The unit's nameplate states the voltage and the unit's total MCA. The main power lines to the unit should be sized accordingly. The nameplate is located on the outside of the unit on the control panel side.

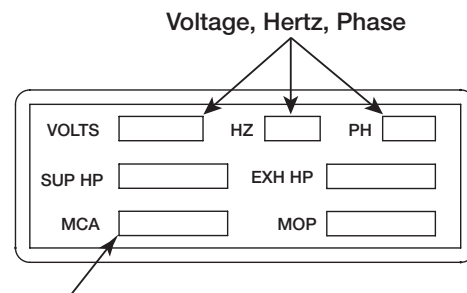

Electrical Nameplate

2. Provide the Opening(s) for the Electrical Connections

Electrical openings vary by unit size and arrangement and are field supplied.

3. Connect the Main Power

Connect the main power lines to the disconnect switch and main grounding lug(s). Torque field connections to 20 in-lbs. See the Control Center Layout in the Reference section for main disconnect and grounding lug(s) locations.

4. Wire the Optional Convenience Outlet

The convenience outlet requires a separate 115V power supply circuit. The circuit must include short circuit protection which may need to be supplied by others.

5. Wire the Optional Accessories

Reference the ladder diagram on the inside of the control center door for correct wiring of the following accessories:

- Blower Switch
- Heat Switch
- Remote Panel (KSCP)

Installation of Gas Piping

IMPORTANT

All gas piping must be installed in accordance with the latest edition of the National Fuel Gas Code ANSI/Z223.1 and any local codes that may apply. In Canada, the equipment shall be installed in accordance with the Installation Code for Gas Burning Appliances and Equipment (CGA B149) and Provincial Regulations for the class. Authorities having jurisdiction should be consulted before installations are made.

IMPORTANT

All piping should be clean and free of any foreign material. Foreign material entering the gas train can cause damage.

WARNING

All components of this or any other gas fired heating unit must be leak tested prior to placing the unit into operation. A soap and water solution should be used to perform this test. NEVER test for gas leaks with an open flame.

IMPORTANT

Do NOT connect the unit to gas types other than what is specified and do NOT connect the unit to gas pressures that are outside of the pressure range shown on the label.

WARNING

When leak testing pressures equal to or less than 14 in. wc (3.5 KPa), first close the field-installed shutoff valve to isolate the unit from the gas supply line.

NOTE

When connecting the gas supply, the length of the run must be considered in determining the pipe size to avoid excessive pressure drop. Refer to a Gas Engineer's Handbook for gas pipe capacities.

NOTE

Each furnace has a single 3/4-inch connection.

1. Determine the Supply Gas Requirements

The unit's nameplate states the requirements for the gas being supplied to the unit.

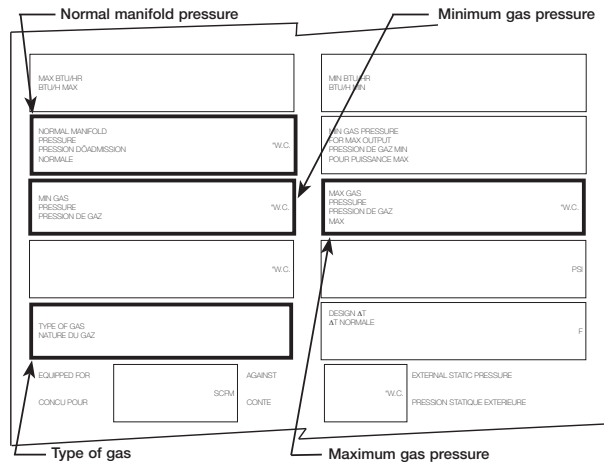

Direct Gas Nameplate

2. Install Additional Regulator if Required

When the supply gas pressure exceeds the maximum gas pressure shown on the unit's nameplate, an additional regulator (by others) is required to reduce the pressure. The regulator must have a listed leak limiting device or it must be vented to the outdoors.

	Supply Gas Pressure Range (inches wc)	
	Minimum	Maximum
Natural	6	14
LP	10	14

3. Connect the Supply Gas Line

A manual shut off valve (gas cock), 1/8 inch plugged test port and 6 inch drip leg must be installed prior to the gas train. The valve and the test port must be accessible for the connection of a test gauge. Supply gas connections must be made by a qualified installer and are not furnished by Greenheck.

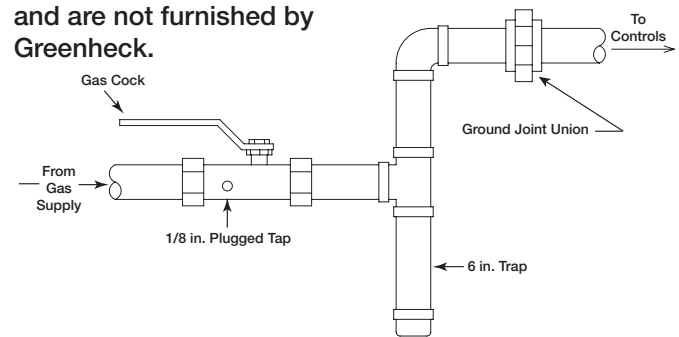

Supply Gas Line

4. Test the System for Leaks

Check both the supply lines and the factory piping for leaks. Apply a soap and water solution to all piping and watch for bubbling which indicates a leak.

WARNING

NEVER test for a gas leak with an open flame.

WARNING

The factory piping has been checked for leaks, but should be rechecked due to shipping and installation.

Start-Up - Blower

Refer to the Start-Up Checklist in the Reference Section Before Proceeding Further!

Pre Start-Up Check

Rotate the fan wheel by hand and make sure no parts are rubbing. Check the V-belt drive for proper alignment and tension (a guide for proper belt tension and alignment is provided in the Belt Maintenance section). Check fasteners, set screws, and locking collars on the fan, bearings, drive, motor base, and accessories for tightness.

WARNING

Disconnect and lock-out all power and gas before performing any maintenance or service to the unit. Failure to do so could result in serious injury or death and damage to equipment.

SPECIAL EQUIPMENT REQUIRED

Required and recommended tools. Equivalent products may be used.

Voltage & Amperage Meter	Manufacturer: Fluke Model: 177 Phone: 1-800-44-FLUKE www.fluke.com
Thermometer	Manufacturer: Fluke Model: 50 Phone: 1-800-44-FLUKE www.fluke.com
Micro Amp Meter	Manufacturer: Fluke Model: 116 Phone: 1-800-44-FLUKE www.fluke.com
U-Tube Manometer	Manufacturer: Dwyer Model: Slack Tube Phone: 1-219-897-8000 www.dwyer-inst.com
Tachometer	Manufacturer: Monarch Model: Pocket Tach 100 Phone: 1-800-999-3390 www.monarchinstrument.com

WARNING

Check the housing, blower, and ductwork for any foreign objects before running the blower.

1. Check the Voltage

Before starting the unit, compare the supplied voltage, hertz, and phase with the unit and motor's nameplate information.

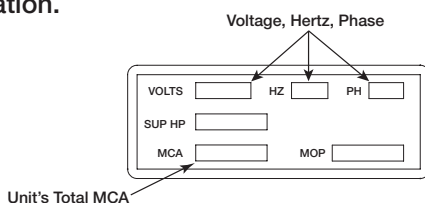

Electrical Nameplate

2. Check the Blower Rotation

Open the blower access door and run the blower momentarily to determine the rotation. Arrows are placed on the blower scroll to indicate the proper direction or reference the example shown to the right.

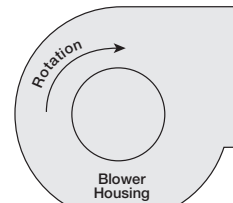

Blower Rotation

NOTE

To reverse the rotation on three phase units, disconnect and lock-out the power, then interchange any two power leads.

NOTE

To reverse the rotation on single phase units, disconnect and lock-out the power, then rewire the motor per the manufacturer's instructions.

IMPORTANT

If the blower is rotating in the wrong direction, the unit will move some air, but will not perform as designed. Be sure to perform a visual inspection to guarantee the correct blower rotation.

3. Check for Vibration

Check for unusual noise, vibration or overheating of the bearings. Reference the Troubleshooting section for corrective actions.

IMPORTANT

Excessive vibration may be experienced during the initial start-up. Left unchecked, it can cause a multitude of problems including structural and/or component failure.

IMPORTANT

Generally, fan vibration and noise is transmitted to other parts of the building by the ductwork. To minimize this undesirable effect, the use of heavy canvas duct connectors is recommended.

4. Motor Check

Measure the motor's voltage, amps and RPM. Compare to the specifications. Motor amps can be reduced by lowering the motor RPM or increasing system static pressure.

5. Air Volume Measurement & Check

Measure the unit's air volume (CFM) and compare it with its rated air volume. If the measured air volume is off, adjust the fan's RPM by changing/adjusting the drive.

NOTE

The most accurate way to measure the air volume is by using a pitot traverse method downstream of the blower. Other methods can be used but should be proven and accurate.

IMPORTANT

Changing the air volume can significantly increase the motor's amps. If the air volume is changed, the motor's amps must be checked to prevent overloading the motor.

NOTE

To ensure accuracy, the dampers are to be open when measuring the air volume.

6. Set-up Optional Components

Adjust the settings on the optional components. See the Control Center Layout in the Reference section for location of optional components.

- Heating Inlet Air Sensor (typical setting: 60-70°F (15-21°C))

Start-Up - Furnaces (all units)

IMPORTANT

For the unit to function properly, all valves must be set for high and low fire.

NOTE

To force the unit to light for set-up purposes, the heat switch must be closed or jumpered out. See the Ladder Diagram on the inside of the control center door for proper terminals to jumper out.

NOTE

If the unit is equipped with an independent inlet air sensor (not incorporated into the stage or modulation controller), the unit will not light unless the outside air temperature is less than the inlet air sensor setting. If the outside air is greater than the inlet air sensor setting, turn the setting to its maximum position. When set-up is complete, reset the inlet air air sensor to the proper temperature. If the unit is equipped with a stage or electronic modulation controller that includes an inlet air sensor function, the inlet air sensor will be overridden when the unit is forced to high fire.

Available Control Options

Single Furnace Units

2:1 Staged	one 2-stage furnace
------------	---------------------

Start-Up - 2:1 Staged Control

1. Send Unit to High Fire

Send the unit to high fire by setting the temperature selector to its maximum setting.

Temperature Selector



2. Check the High Fire Manifold Pressure

Using a manometer, measure the burner manifold pressure at the manifold pressure test port. Refer to the Gas Train Layout in the Reference section for the test port location.

The pressure on high fire should be 3-1/2 inches wc for natural gas and 10 inches wc for LP gas.

If needed, use the high fire adjustment screw on the combination gas valve to adjust the high fire manifold pressure. Counterclockwise rotation will decrease the gas pressure and clockwise rotation will increase the gas pressure.

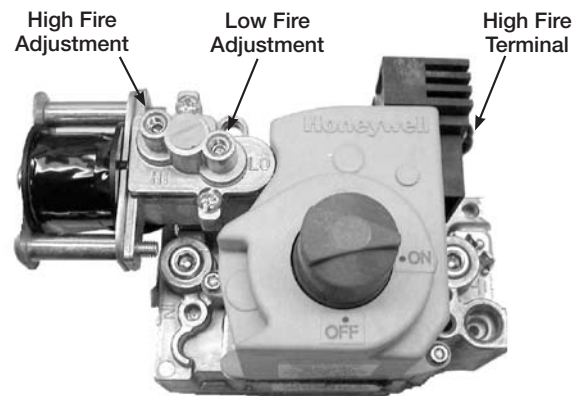

3. Send Unit to Low Fire

Remove and isolate the wire from the high fire terminal on the combination gas valve to send the unit to low fire.

4. Check the Low Fire Manifold Pressure

Using a manometer, measure the burner manifold pressure at the manifold pressure test port. Refer to the Gas Train Layout in the Reference section for the test port location.

The pressure on low fire should be 7/8 inches wc for natural gas and 2-1/2 inches wc for LP gas.

	Two Stage Manifold Pressure (inches wc)	
	Natural Gas	LP
Low Fire	7/8	2-1/2
High Fire	3-1/2	10

If needed use the low fire adjustment screw on the combination gas valve to adjust the low fire manifold pressure. Counterclockwise rotation will decrease the gas pressure and clockwise rotation will increase the gas pressure. Once the low fire manifold pressure is set, reattach the high fire wire to the high fire terminal.

5. Reset the Temperature Setting

Reset the temperature setting on the temperature selector to the desired setting.

Sequence of Operation

2:1 Staged Sequence

1. Optional supply fan switch (S2) manually closed

(If no supply fan switch is installed, power will automatically be supplied to the supply starter overload (ST1 OL) when the unit is powered)

- Power passes through N.C. supply starter overload (ST1 OL) which is closed if the supply fan has not overloaded
- Power reaches supply fan starter (ST1)
- N.O. supply fan starter (ST1) is energized and closed
- Power passes through the N.O. supply starter auxiliary contact (ST1 (AUX)) and energizes optional inlet damper (D1) which opens
- Power reaches and energizes supply fan (M1)

2. Optional heat switch (S3) manually closed

(If no heat switch is installed, power will automatically be supplied to the supply starter relay (ST1) when the unit is powered)

- Power passes through the high temperature limit switch (HLC) which is closed if the discharge temperature is not higher than the high temperature limit switch set point
- Power passes through N.O. supply fan starter relay (ST1) which is energized and closed
- Power passes through the N.O. inlet air sensor (TS1) which is closed if inlet air temperature has remained below the set point
- Power passes to the discharge temperature stage controllers (SC1 & SC2)
- If the discharge air temperature sensed by the discharge air sensor (TS2) is less than the stage one controller (SC1) set point, the furnace stage one controller (SC1) N.O. contact will close, powering the ignition controller (IC)
- If the discharge air temperature is also less than the stage one controller (SC1) set point minus the stage two controller (SC2) offset, the furnace stage two controller (SC2) N.O. contact will also close
- The ignition controller (IC) will begin its sequence of operation

3. Ignition Controller (IC) Sequence of Operation

- The N.O. air proving switch (PS2) is open
- The ignition controller (IC) energizes the combustion blower (CM)
- The N.O. low air proving switch (PS2) closes
- The ignition controller completes a 15 second pre-purge
- The high fire timer relay (RT3) is energized and the N.O. contact passes power to the high fire terminal on the combination gas valve (MV)
- The combination gas valve (MV) fully opens (100%)
- 10 second trial for ignition period begins
- Igniter (SPARK) begins sparking
- The furnace will light at high fire (100%)
- When the flame is detected by the flame sense electrode (SENSOR) the igniter (SPARK) stops sparking
- The furnace will remain at high fire (100%) for 10 seconds
- The high fire timer expires and the N.O. contact opens, allowing the stage two controller (SC2) to control the power to the high fire terminal of the combination gas valve (MV)

4. High Fire – Low Fire Sequence of Operation

- The furnace lights at high fire (100%), and remains at high fire for 10 seconds
- If the discharge temperature sensor (TS2) is above the stage one controller (SC1) set point minus the stage two controller (SC2) offset, the stage two controller (SC2) contact will open and the furnace will go to low fire (50%)
- If the furnace is at low fire (50%) and the discharge temperature sensor (TS2) is above the stage one controller (SC1) set point, the furnace stage one controller (SC1) contact will open and the furnace will shut down
- If the furnace is at low fire (50%), and the discharge temperature sensor (TS2) remains below the stage one controller (SC1) set point minus the stage two controller (SC2) offset, the furnace stage two controller (SC2) contact will close and the furnace will go to high fire (100%)

Troubleshooting

Blower Does Not Operate

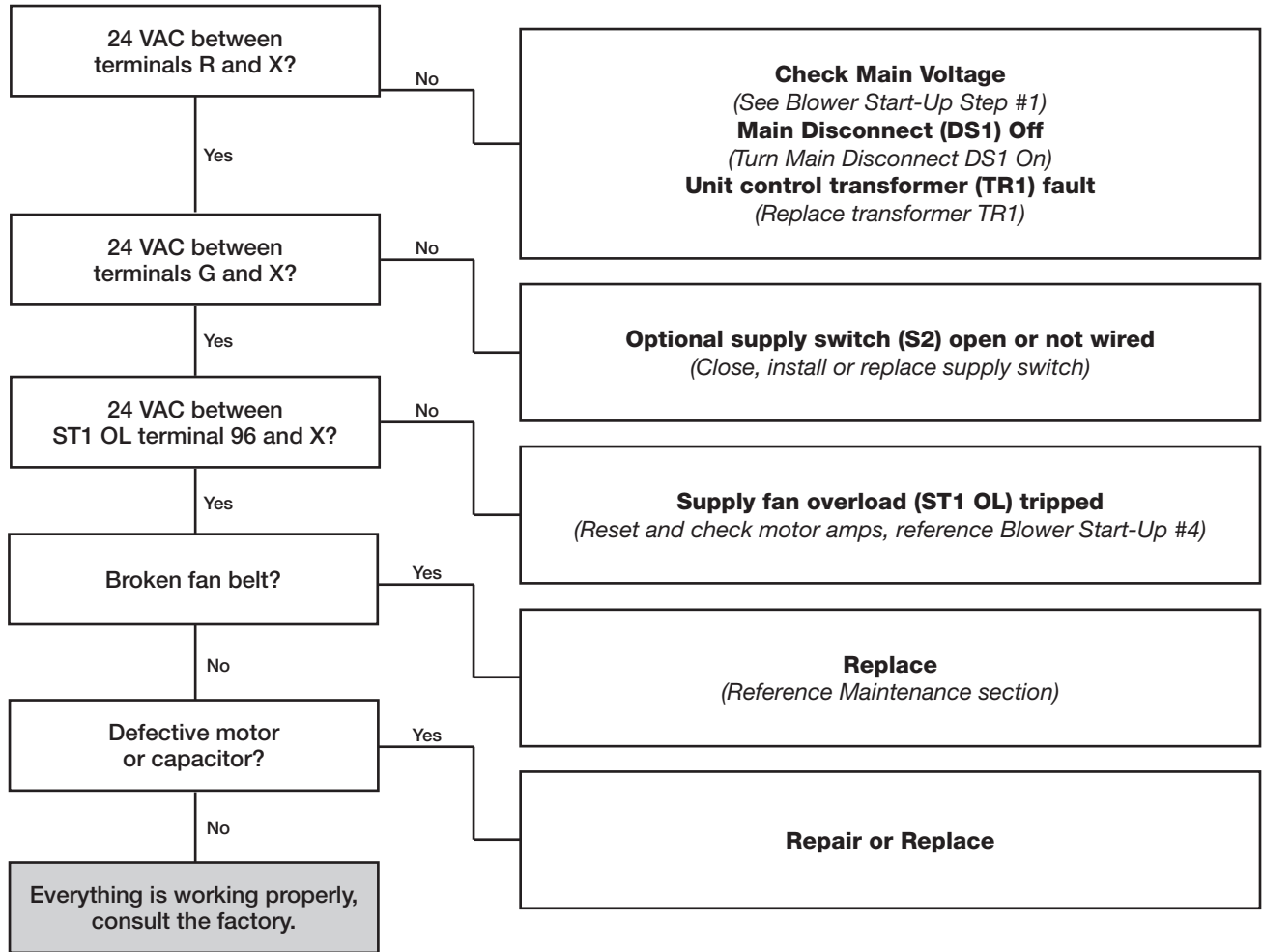

Troubleshooting

Motor Overamps

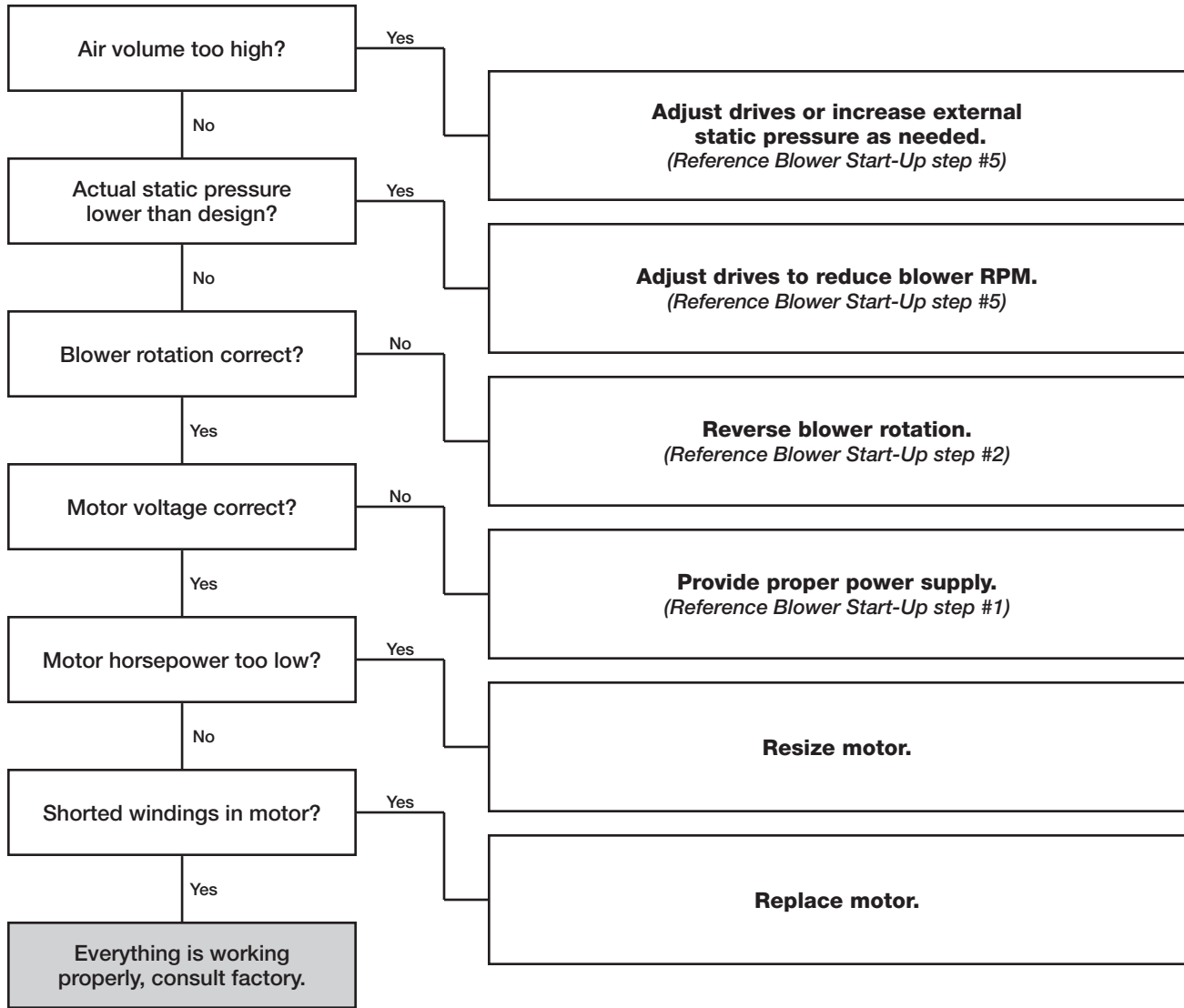

Too Much Airflow

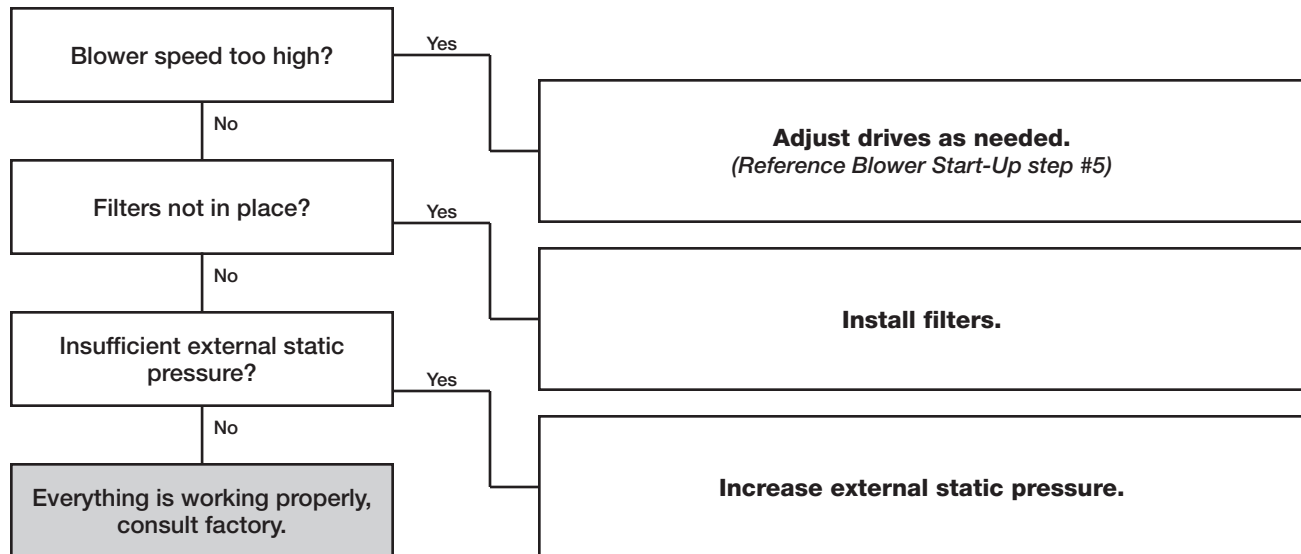

Troubleshooting

Excessive Noise or Vibration

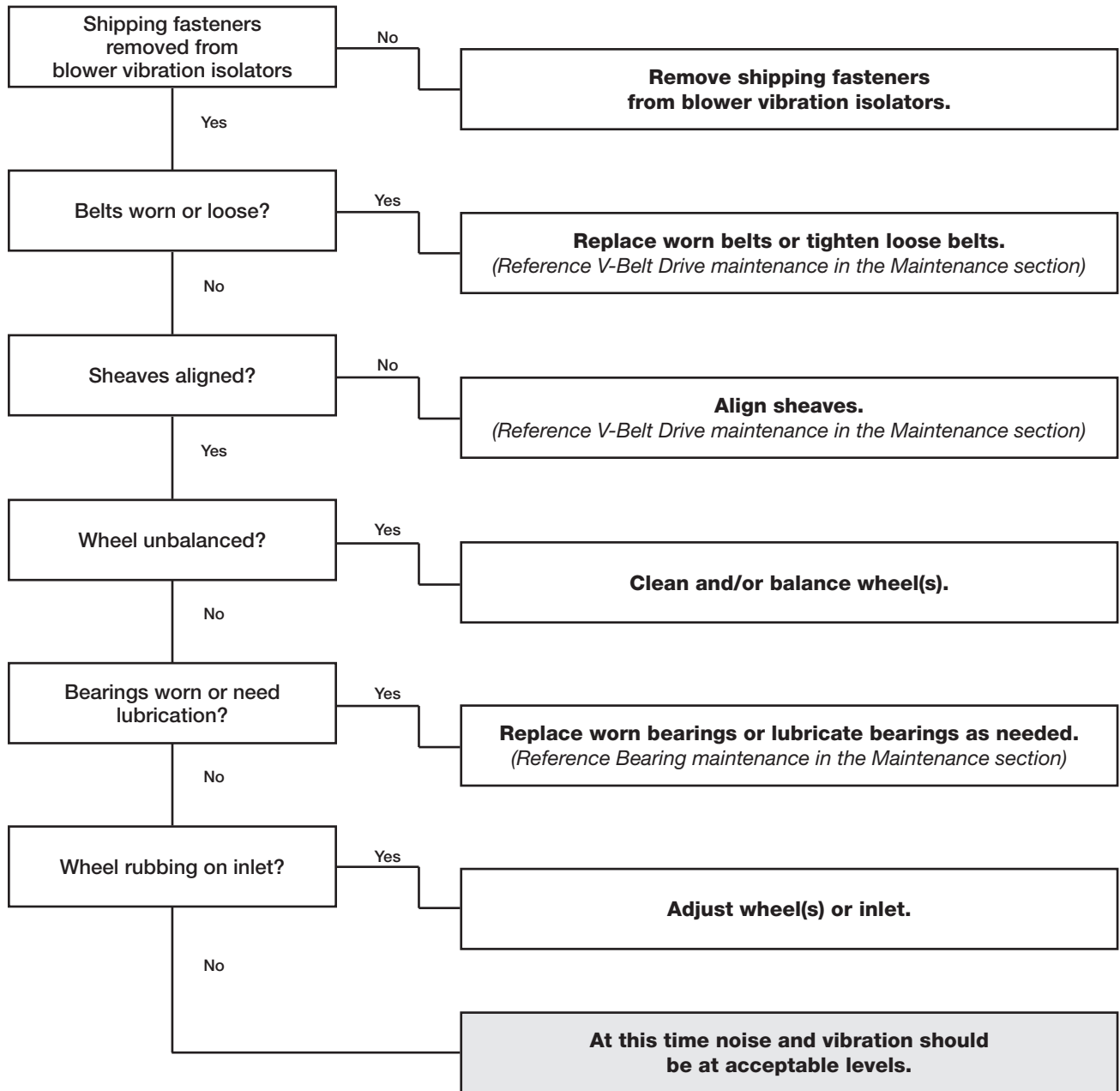

Troubleshooting

Insufficient Airflow

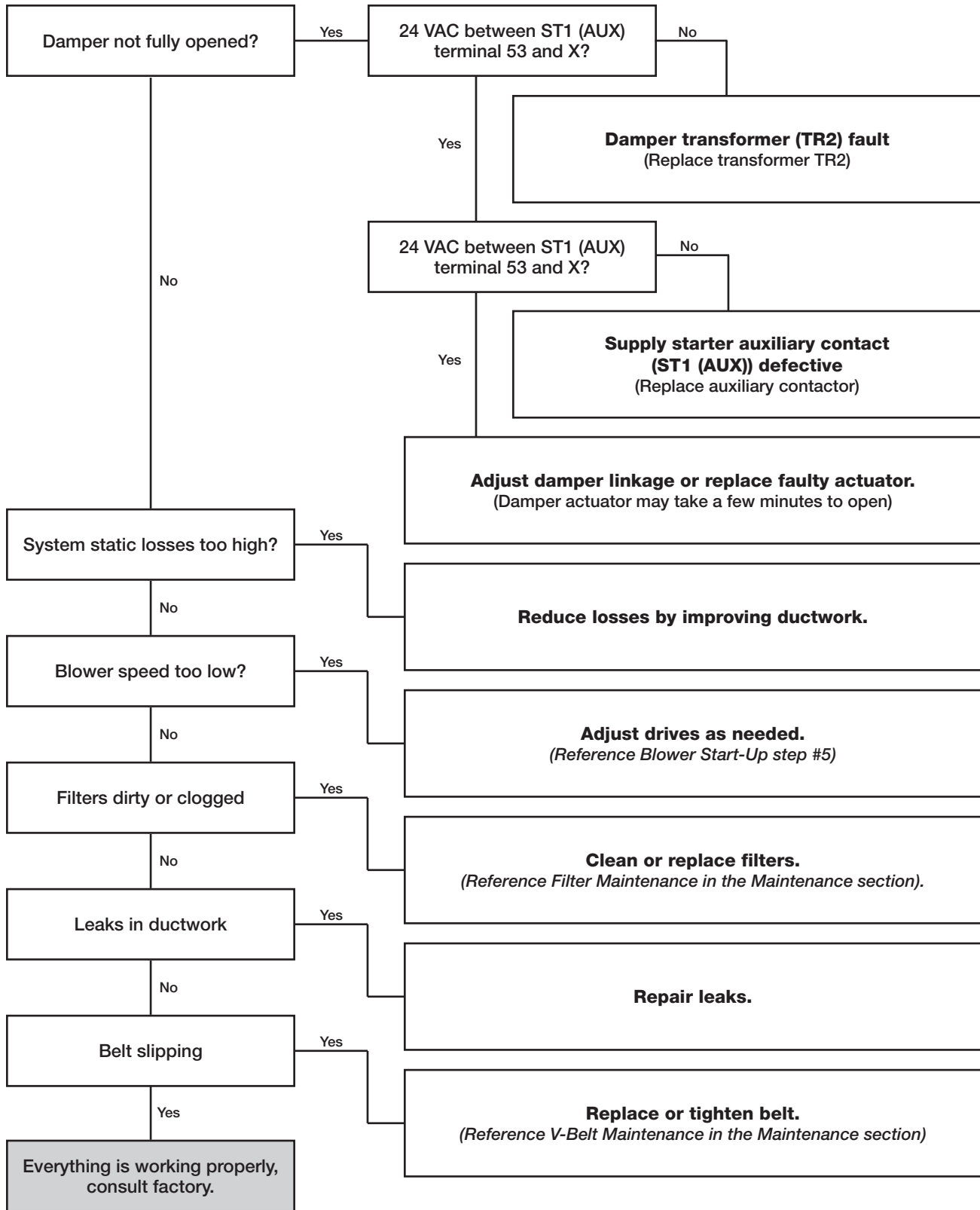

Troubleshooting

2:1 Staged Furnace Will Not Light

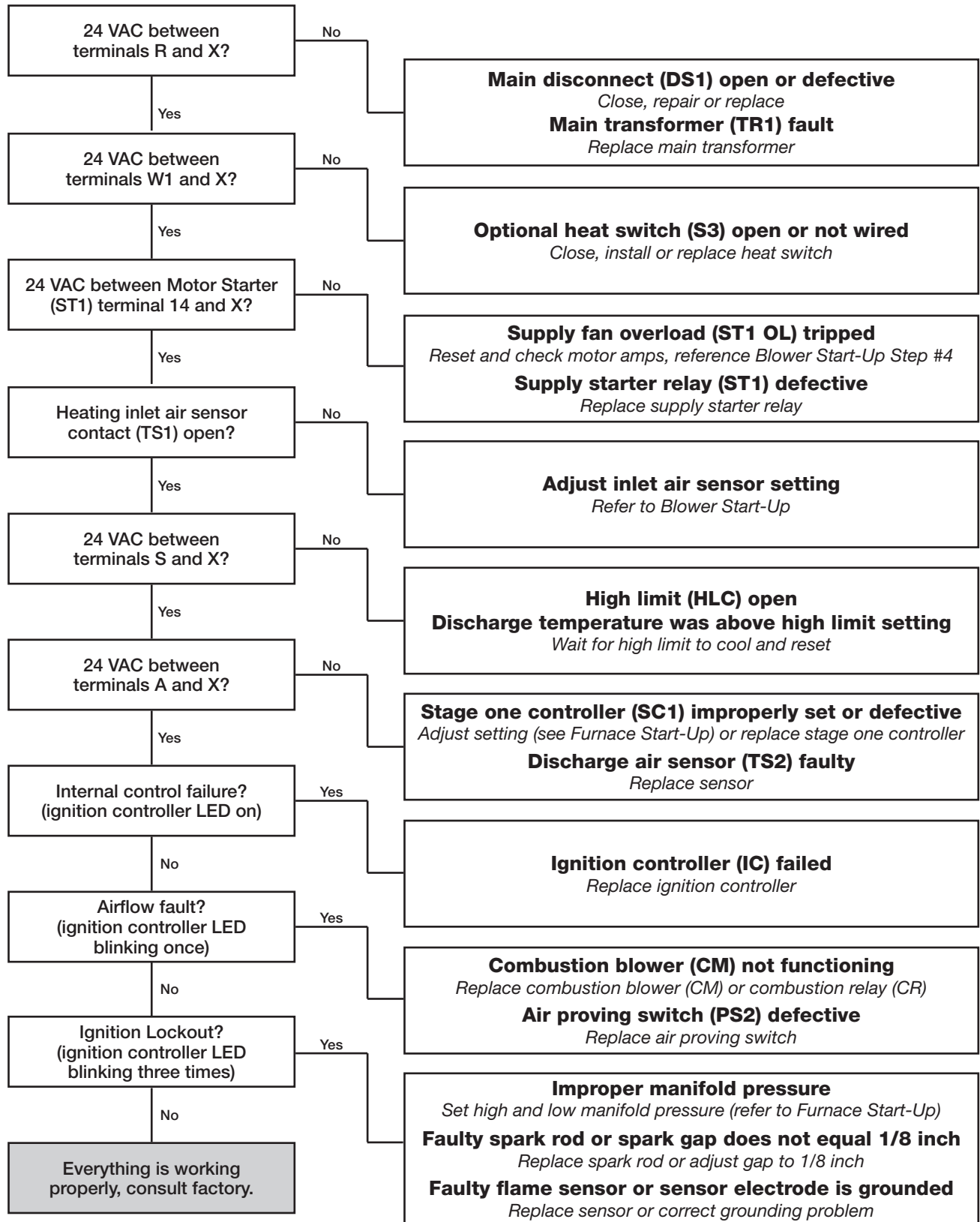

Maintenance - Routine

CAUTION

Lock-out the gas and the electrical power to the unit before performing any maintenance or service operations to this unit.

V-Belt Drives

V-belt drives must be checked on a regular basis for wear, tension, alignment, and dirt accumulation.

Check the tension by measuring the deflection in the belt as shown below.

Check the alignment by using a straight edge across both sheaves as shown below.

IMPORTANT

Premature or frequent belt failures can be caused by improper belt tension, or misaligned sheaves.

- Abnormally high belt tension or drive misalignment will cause excessive bearing loads and may result in failure of the fan and/or motor bearings.
- Abnormally low belt tension will cause squealing on start-up, excessive belt flutter, slippage, and overheated sheaves.

IMPORTANT

Do not pry belts on or off the sheave. Loosen belt tension until belts can be removed by simply lifting the belts off the sheaves.

IMPORTANT

When replacing V-belts on multiple groove drives, all belts should be changed to provide uniform drive loading.

IMPORTANT

Do not install new belts on worn sheaves. If the sheaves have grooves worn in them, they must be replaced before new belts are installed.

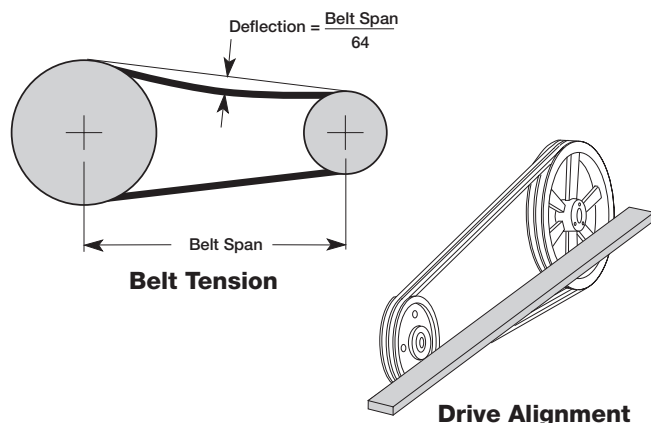

Snow Accumulation

Clear snow away from roof mounted units. Keep the snow clear of the intake and access doors.

Motors

Motor maintenance is generally limited to cleaning and lubrication (where applicable).

Cleaning should be limited to exterior surfaces only. Removing dust and grease build-up on the motor assures proper motor cooling.

Motors supplied with grease fittings should be greased in accordance with the manufacturer's recommendations.

IMPORTANT

Do not allow water or solvents to enter the motor or bearings. Motors and bearings should never be sprayed with steam, water or solvents.

IMPORTANT

Greasing motors is only intended when fittings are provided. Many motors are permanently lubricated, requiring no additional lubrication.

Wheels

Wheels require little attention when moving clean air. Occasionally oil and dust may accumulate on the wheel causing imbalance. When this occurs the wheel and housing should be cleaned to assure proper operation.

Filters

Filter maintenance is generally limited to cleaning and replacement.

If aluminum mesh filters are installed, they can be washed in warm soapy water.

An adhesive spray can be added to aluminum mesh filters to increase their efficiency.

If disposable filters are installed, they can be checked by holding up to a light source. If light cannot pass through the filter, it should be replaced.

IMPORTANT

When reinstalling filters, be sure to install them with the airflow in the correct direction. An airflow direction arrow is located on the side of the filters.

IMPORTANT

Replacement filters should be from the same manufacturer and the same size as the original filters provided with the unit.

Maintenance - Routine *continued*

Bearings

The bearings for Greenheck fans are carefully selected to match the maximum load and operating conditions of the specific class, arrangement and fan size. The instructions provided in this manual and those provided by the bearing manufacturer will minimize any bearing problems.

IMPORTANT

Lubricate bearings prior to periods of extended shutdowns or storage and rotate shaft monthly to aid in corrosion prevention. If the fan is stored more than three months, purge the bearings with new grease prior to start-up.

Fan RPM	Bearing Bore Size (inches)				
	½ - 1	1½ - 1½	1⅝ - 1⅞	1 ¹⁵ / ₁₆ - 2 ³ / ₁₆	2 ⁷ / ₁₆ - 3
250	6	6	6	6	6
500	6	6	6	5	4
750	6	5	4	3	3
1000	5	3	2	1	1
1250	5	3	2	1	1
1500	5	2	1	1	0.5
2000	5	1	1	0.5	0.25

*Suggested initial greasing interval is based on 12 hour per day operation and 150°F maximum housing temperature. For continuous (24 hour) operation, decrease greasing interval by 50%

- If extended grease lines are present, relubricate while in operation, only without endangering personnel.
- For ball bearings (operating) relubricate until clean grease is seen purging at the seals. Be sure not to unseat the seal by over lubricating.
- For ball bearings (idle) add 1-2 shots of grease up to 2 inch bore size, and 4-5 shots above 2 inch bore sizes with a hand grease gun.
- For roller bearings add 4 shots of grease up to 2 inch bore size, and 8 shots for 2-5 inch bore size with a hand grease gun.
- Adjust relubrication frequency based on condition of purged grease.
- A high quality lithium based grease conforming to NLGI Grade 2 consistency, such as those listed here:
Mobil 532 Texaco Multifak #2 B Shell Alavania #2
Mobilux #2 Texaco Premium #2 Exxon Unirex #2

Maintenance - Fall

Gas Line

Remove the drip leg and clean any liquid or debris that may have accumulated. Once the drip leg is cleaned, reattach it.

Gas Train

Gas connections, joints and valves should be inspected for tightness. Apply a soap and water solution to all piping; watch for bubbling which indicates a leak. Other leak testing methods can be used.

Burners and Orifices

Before each heating season, examine the burners and gas orifices to make sure they are clear of any debris such as spider webs, etc. Clean burner as follows:

- Turn off both electrical and gas supplies to the unit.
- Disconnect union between manifold and gas valve.
- Remove manifold and burner assembly.
- Inspect and clean orifices and burners as necessary. Avoid using any hard or sharp instruments which could cause damage to the orifices or burners.
 - Remove any soot deposits from the burner with a wire brush.
 - Clean the ports with an aerosol degreaser or compressed air.
 - Wipe the inside of the burner clean. Cleaning the burner with a degreaser will slow the future build-up of dirt.
- Before reinstalling the burner assembly, make sure the heat exchanger tubes are clear of any debris.
- Reinstall manifold and burner assembly, reconnect wire leads and gas supply piping.
- Turn on the electrical power and gas supply.
- Follow the start-up procedure to light the burners and verify proper operation.

Heat Exchanger

The heat exchanger should be checked annually for cracks. If a crack is detected, the heat exchanger should be replaced before the unit is put back into operation. Airflow across the heat exchanger should be checked to make sure the blower is operating properly.

Flue Collector Box

The flue passage and collector box should be checked prior to each heating season and cleared of any debris.

Electrical Wiring

The electrical wiring should be checked annually for loose connections or deterioration.

Replacement Parts

When ordering replacement parts, include the unit model and serial number listed on the nameplate.

Reference - Venting Connection Location

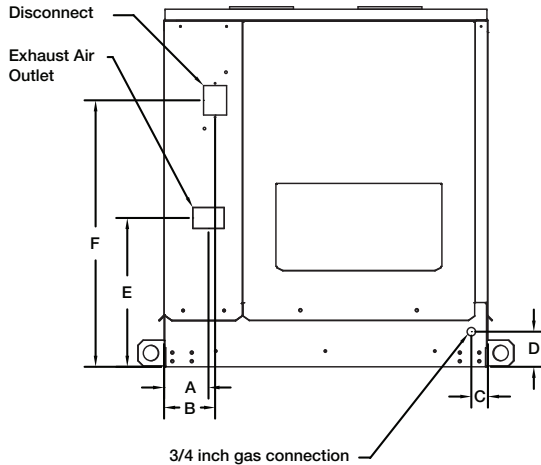

Venting Connection

Housing	A	B	C	D	E	G	Flue Connection
H05	4.33	4.98	1.62	3.43	14.52	26.00	4.00
H15	8.09	7.38	3.87	3.62	15.43	28.37	6.00

Dimensions are in inches.

Reference - Typical Gas Train Layout

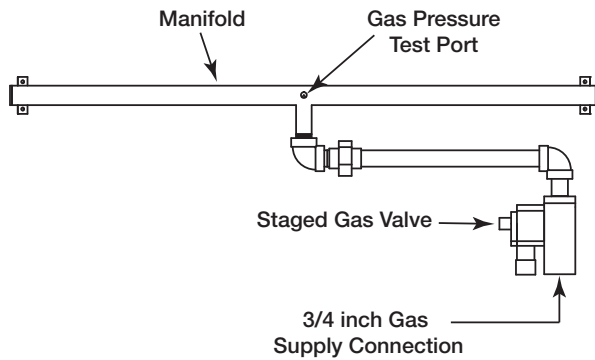

Typical IGK Gas Train Layout

Reference - Performance Table

The following table gives the air volume in standard cubic feet per minute (SCFM) that is required to provide the desired temperature rise for a given heating input. Model IGK has a maximum 5,000 CFM capacity.

Input (MBH)	Output (MBH)	Temperature Rise (°F)															
		25	30	35	40	45	50	55	60	65	70	75	80	85	90	95	100
100	80	2963	2469	2116	1852	1646	1481	1347	1235	1140	1058	988	926	871	823	780	741
150	120	4444	3704	3175	2778	2469	2222	2020	1852	1709	1587	1481	1389	1307	1235	1170	1111
200	160	NA	4938	4233	3704	3292	2963	2694	2469	2279	2116	1975	1852	1743	1646	1559	1481
250	200	NA	NA	NA	4630	4115	3704	3367	3086	2849	2646	2469	2315	2179	2058	1949	1852
300	240	NA	NA	NA	NA	4938	4444	4040	3704	3419	3175	2963	2778	2614	2469	2339	2222
350	280	NA	NA	NA	NA	NA	NA	4714	4321	3989	3704	3457	3241	3050	2881	2729	2593
400	320	NA	NA	NA	NA	NA	NA	NA	4938	4558	4233	3951	3704	3486	3292	3119	2963

Reference - Control Center Layout

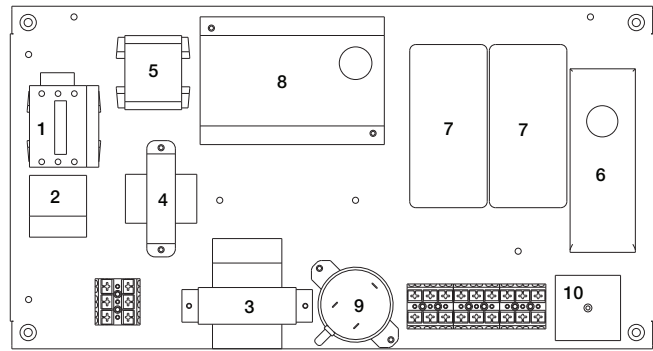

NOTE

Reference the ladder diagram on the inside of the control center door for a unit specific wiring diagram.

- Supply Motor Starter** - 24 volt magnetic contacts for starting supply motor.
- Supply Overload** - Provides electronic overload protection to supply motor.
- Transformer** - Provides voltage to combustion blower.
- Low Voltage Transformer (Optional)** - Provides low voltage to enable damper.
- Combustion Fan Relay** - Allows power to pass to enable combustion fan on a call for heating.
- Inlet Air Sensor** - Outdoor air stat that automatically controls the heating and/or cooling based on outdoor air temperature.
- Stage Controller** - Provide two stages of control based on discharge air temperature set point.
- Ignition Controller** - Controls the ignition and maintains safe operation of the furnace.
- Airflow Switch** - Monitors the airflow inside the heat exchanger to ensure proper combustion airflow.
- Time Delay** - Allows furnace to ignite on high-fire.

Reference - Control Flow Diagram

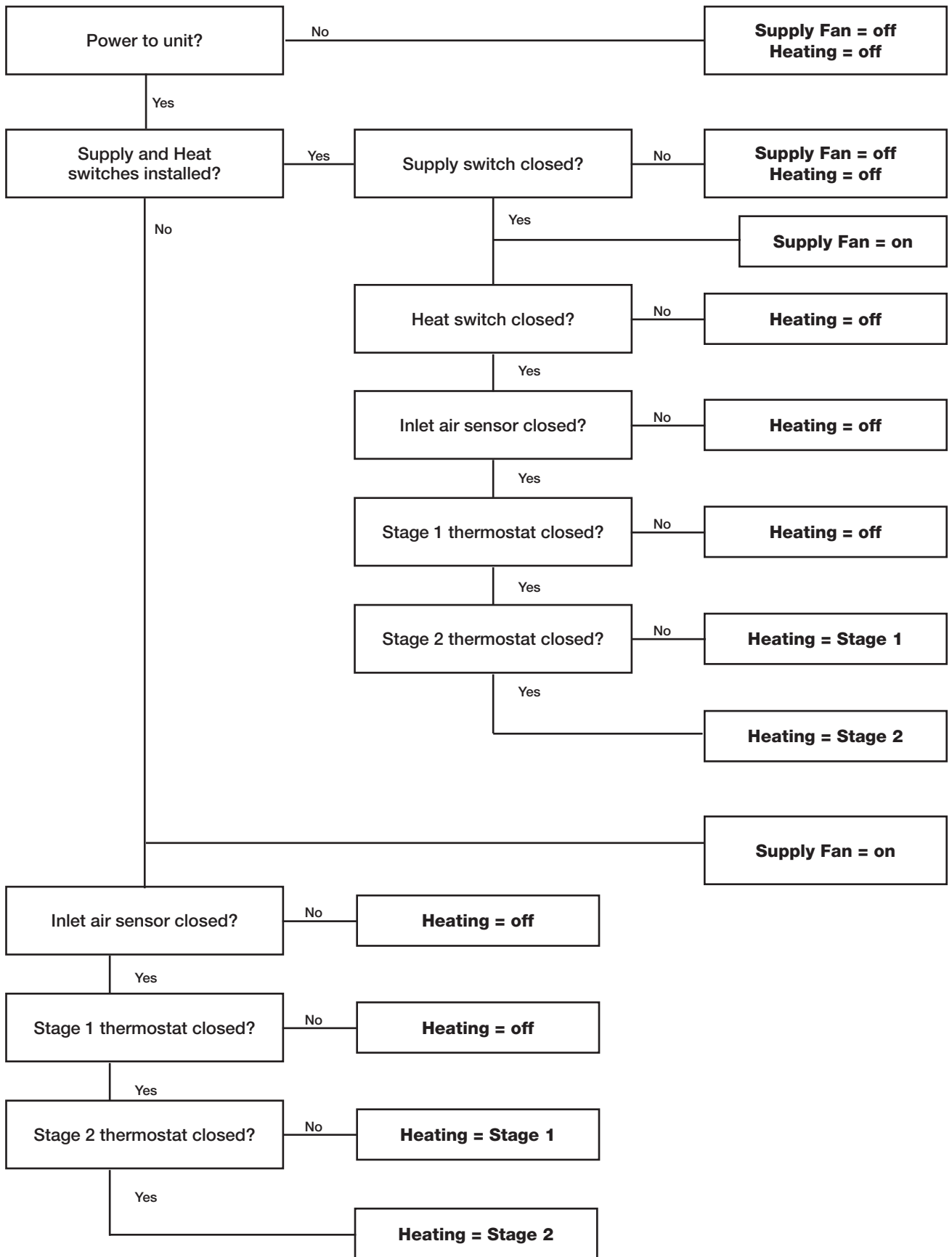

Reference - Typical Single Phase Wiring Diagram (115 volt)

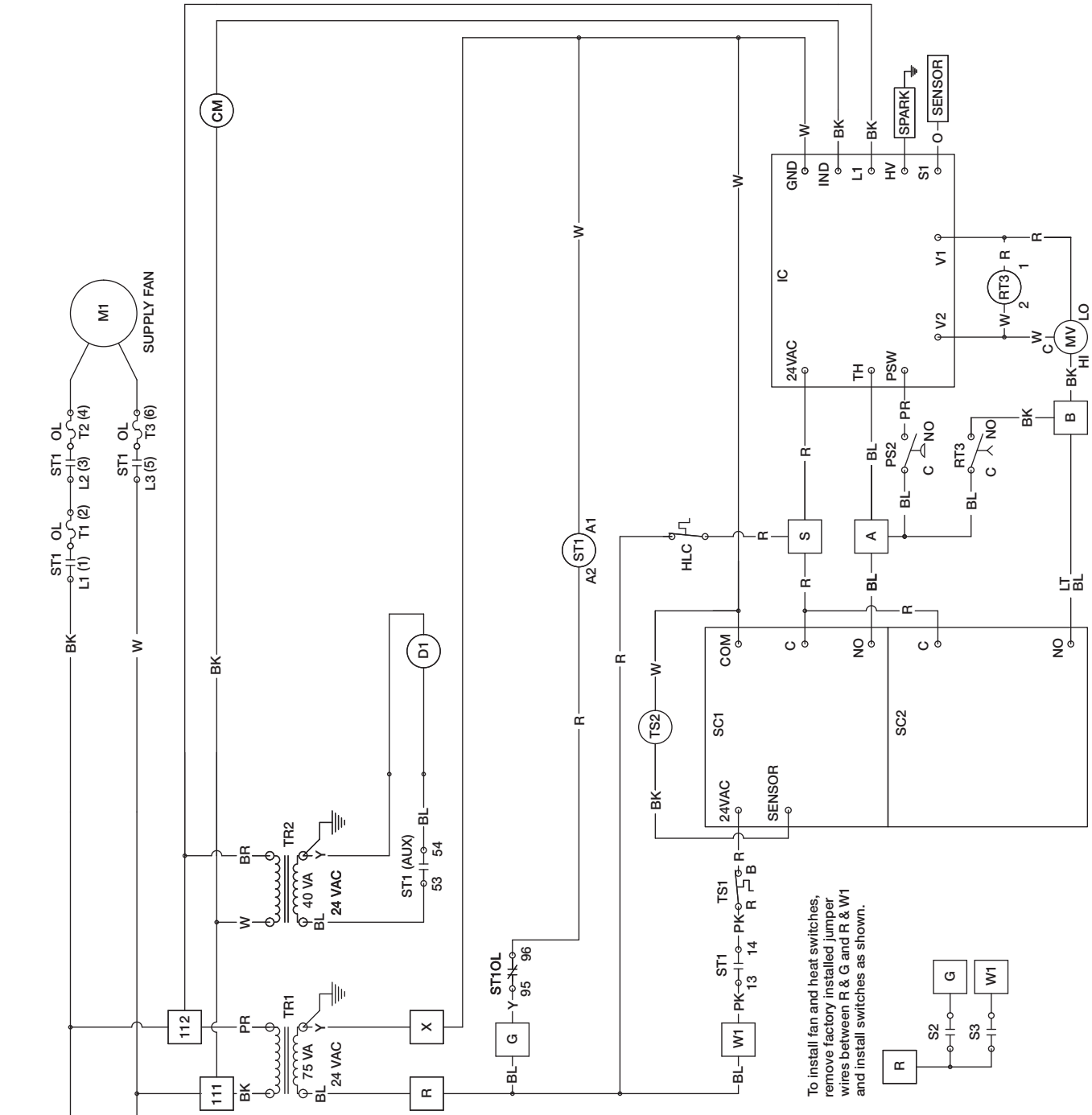

To install fan and heat switches, remove factory installed jumper wires between R & G and R & W1 and install switches as shown.

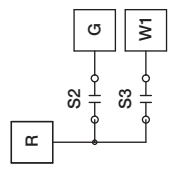

Wire Color Code:

- BK Black
- BR Brown
- O Orange
- PR Purple
- W White
- BL Blue
- LT BL Light Blue
- PK Pink
- R Red
- Y Yellow

Factory Supplied Components:

- CM Combustion Fan
- CR Combustion Relay
- D1 Inlet Damper
- DS1 Main Disconnect
- HLC High Limit Control
- IC Ignition Controller
- M1 Supply Fan Motor
- OL Combination Gas Valve
- PS2 Supply Overload
- RT3 Air Proving Switch
- RT4 Freeze Timer Relay
- SC1 Stage 1 Controller
- SC2 Stage 2 Controller
- SD Freeze Discharge Sensor
- SENSOR Ignition Flame Sensor
- SPARK Ignition Spark Electrode
- ST1 Supply Motor Starter
- ST1 (AUX) Supply Starter Auxiliary Contact
- TR1 Main Transformer
- TR2 Damper Transformer
- TS1 Inlet Air Sensor
- TS2 Discharge Temperature Sensor

Field Supplied Components:

- S2 Supply Fan Switch
- S3 Heat Switch



Maintenance Start-Up Record

Start-Up Checklist

Unit Model Number _____ (e.g. IGK-112-H15-DB)
Unit Serial Number _____ (e.g. 10111000)
Start-up date _____ (MM/DD/YYYY)
Start-up Personnel Name _____
Start-up Company _____
Phone Number _____

Pre Start-Up Checklist - check boxes as items are completed

- Check tightness of all factory wiring connections
- Verify control wiring wire gauge
- Hand-rotate blower to verify free rotation
- Verify supply voltage to the main disconnect
- Verify the supply gas pressure
- Verify remote controls wiring

Start-Up Blower Checklist - refer to Blower Start-Up section for further detail

- Check line voltage L1-L2 _____ L2-L3 _____ L1-L3 _____
- Check blower rotation
- Check for vibration
- Supply fan RPM _____ RPM
- Motor nameplate amps _____ Amps
- Actual motor amps _____ Amps
- Actual CFM delivered _____ CFM

Optional Accessories - refer to Blower Start-Up section, step #6 for further detail

- Heating inlet air sensor _____ Actual Setting (Typical Setting 60-70° F)

Start-Up Indirect Gas - refer to Furnace Start-Up section for further detail

2 Stage furnace control type

- Check supply gas pressure _____ Maximum _____ Minimum _____ Actual
- Set the High Manifold pressure _____ Inches wg
- Set the Low Manifold pressure _____ Inches wg
- Set the unit's operating temperature _____ degrees F



Maintenance Log

Date _____ Time _____ AM/PM

Notes: _____

Date _____ Time _____ AM/PM

Notes: _____

Date _____ Time _____ AM/PM

Notes: _____

Date _____ Time _____ AM/PM

Notes: _____

Date _____ Time _____ AM/PM

Notes: _____

Date _____ Time _____ AM/PM

Notes: _____

Date _____ Time _____ AM/PM

Notes: _____

Date _____ Time _____ AM/PM

Notes: _____

Date _____ Time _____ AM/PM

Notes: _____

Date _____ Time _____ AM/PM

Notes: _____

Date _____ Time _____ AM/PM

Notes: _____

Date _____ Time _____ AM/PM

Notes: _____

Warranty

Greenheck warrants this equipment to be free from defects in material and workmanship for a period of one year from the purchase date. Any units or parts which prove defective during the warranty period will be replaced at our option when returned to our factory, transportation prepaid. Motors are warranted by the motor manufacturer for a period of one year. Should motors furnished by Greenheck prove defective during this period, they should be returned to the nearest authorized motor service station. Greenheck will not be responsible for any removal or installation costs.

As a result of our commitment to continuous improvement, Greenheck reserves the right to change specifications without notice.

Greenheck Catalog IGK provide additional information describing the equipment, fan performance, available accessories, and specification data.

AMCA Publication 410-96, Safety Practices for Users and Installers of Industrial and Commercial Fans, provides additional safety information. This publication can be obtained from AMCA International, Inc. at: www.amca.org.



Phone: (715) 359-6171 • Fax: (715) 355-2399 • E-mail: gfcinfo@greenheck.com • Website: www.greenheck.com